

InteliLite NT[®]

Operator Guide



December 2008
Copyright © 2007 ComAp s.r.o.
Written by Adela Prochazkova
Prague, Czech Republic





ComAp, spol. s r.o.
Kundratka 2359/17, 180 00 Praha 8, Czech Republic
Tel: +420 246 012 111, Fax: +420 246 316 647
E-mail: info@comap.cz, www.comap.cz

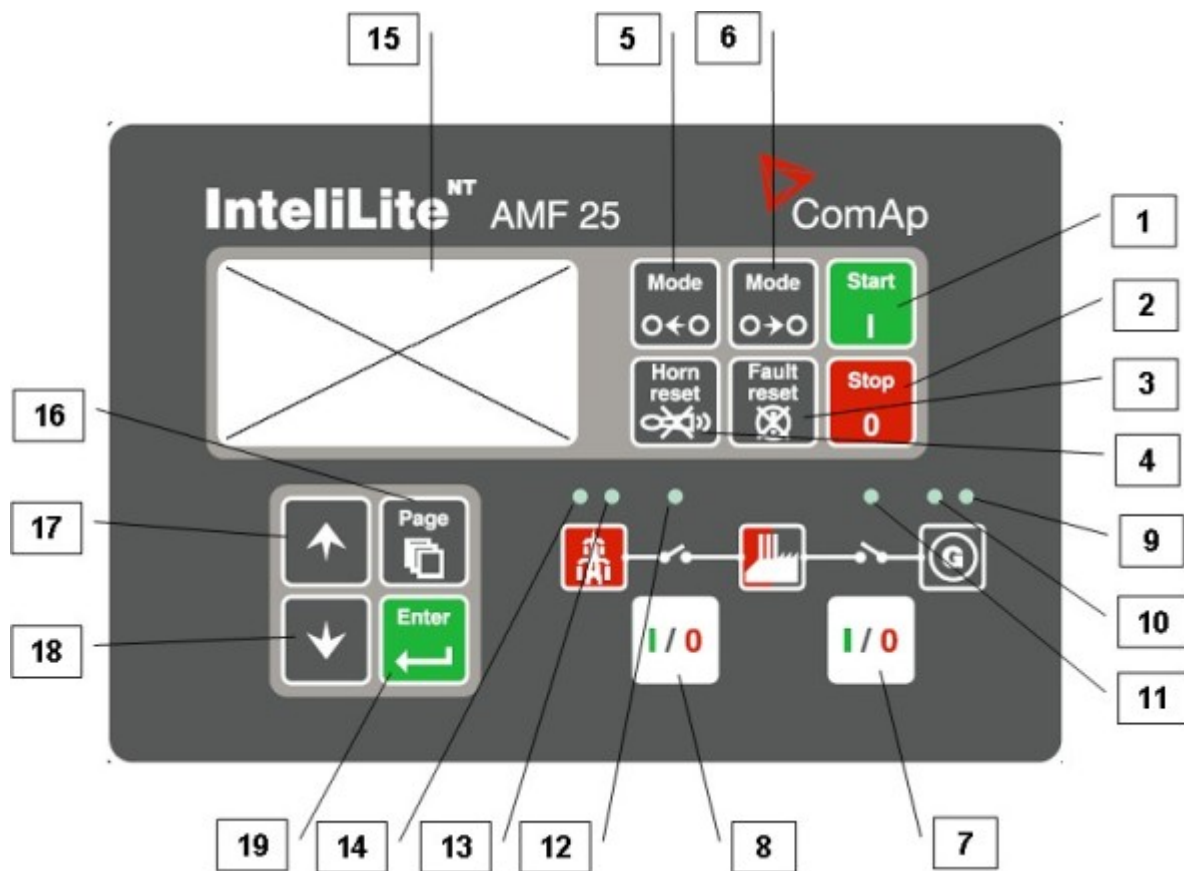



Operator Interface AMF



GEN-SET CONTROL BUTTONS





POSITION	BUTTON	DESCRIPTION
1		START button. Works in MAN mode only. Press this button to initiate the start sequence of the engine.
2		STOP button. Works in MAN mode only. Press this button to initiate the stop sequence of the gen-set. Repeated pressing or holding the button for more than 2s will cancel current phase of stop sequence (like ramping the power down or cooling) and next phase will continue.
3		FAULT RESET button. Use this button to acknowledge alarms and deactivate the horn output. Inactive alarms will disappear immediately and status of active alarms will be changed to "confirmed" so they will disappear as soon as their reasons dismiss.
4		HORN RESET button. Use this button to deactivate the horn output without acknowledging the alarms.
5		MODE LEFT button. Use this button to change the mode. The button works only if the main screen with the indicator of currently selected mode is displayed. NOTE: This button will not work if the controller mode is forced by one of binary inputs Remote OFF, Remote MAN, Remote AUT, Remote TEST.

6		<p>MODE RIGHT button. Use this button to change the mode. The button works only if the main screen with the indicator of currently selected mode is displayed.</p> <p>NOTE: This button will not work if the controller mode is forced by one of binary inputs Remote OFF, Remote MAN, Remote AUT, Remote TEST.</p>
7		<p>GCB button. Works in MAN mode only. Press this button to open or close the GCB manually. Note that certain conditions must be valid otherwise GCB closing is blocked.</p>
8		<p>MCB button. Works in MAN mode only. Press this button to open or close the MCB manually.</p> <p>CAUTION! You can disconnect the load from the mains supply with this button! Be sure you know well what you are about to do!</p>

GEN-SET OPERATION INDICATORS

POSITION	INDICATOR DESCRIPTION
9	<p>Gen-set failure. Red LED starts flashing when gen-set failure occurs. After FAULT RESET button is pressed, goes to steady light (if an alarm is still active) or is off (if no alarm is active).</p>
10	<p>Gen-set voltage OK. Green LED is on if the generator voltage is present and within limits.</p> <p>NOTE: The limits for the generator voltage and frequency are given by setpoints in the Gener Protect group.</p>
11	<p>GCB ON. Green LED is on, if GCB is closed. It is driven by GCB CLOSE/OPEN output (AMF 8/9) or by GCB feedback signal (AMF 20/25).</p>
12	<p>MCB ON. Green LED is on, if MCB is closed. It is driven by MCB CLOSE/OPEN output (AMF 8/9) or by MCB feedback signal (AMF 20/25).</p>
13	<p>Mains voltage OK. Green LED is on, if mains is present and within limits.</p>
14	<p>Mains failure. Red LED starts blinking when the mains failure is detected and after the gen-set has started and connected to the load it lights permanently until the mains failure disappears.</p>





DISPLAY AND CONTROL BUTTONS

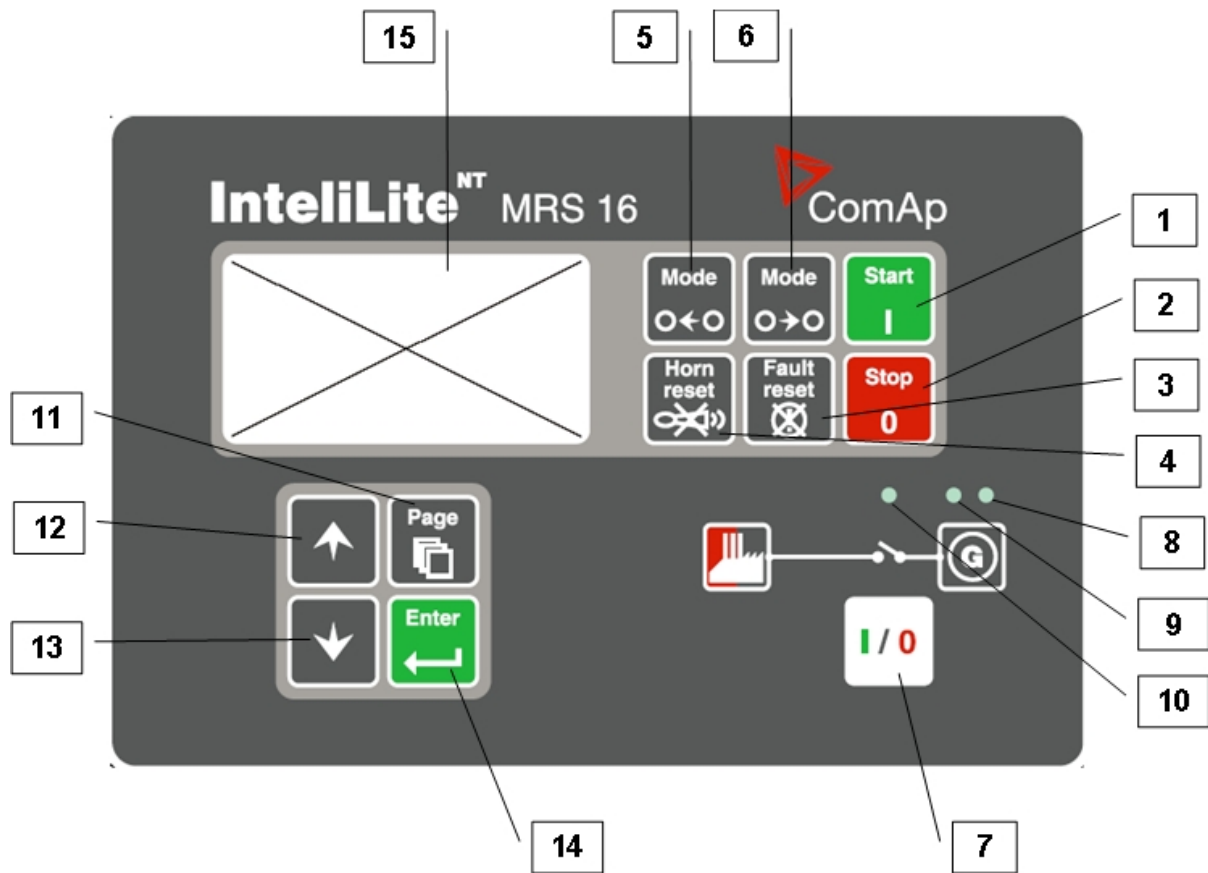

POSITION	BUTTON	DESCRIPTION
15		Graphic B/W display, 128x64 pixels
16		<p>PAGE button. Use this button to switch over display pages. See Display Screens and Pages Structure chapter below this table for more details.</p>
17		<p>UP button. Use this button to move up or increase a value.</p>
18		<p>DOWN button. Use this button to move down or decrease a value.</p>
19		<p>ENTER button. Use this button to finish editing a setpoint or moving right in the history page.</p>

Operator Interface MRS



GEN-SET CONTROL BUTTONS





POSITION	BUTTON	DESCRIPTION
1		START button. Works in MAN mode only. Press this button to initiate the start sequence of the engine.
2		STOP button. Works in MAN mode only. Press this button to initiate the stop sequence of the gen-set. Repeated pressing or holding the button for more than 2s will cancel current phase of stop sequence (like ramping the power down or cooling) and next phase will continue.
3		FAULT RESET button. Use this button to acknowledge alarms and deactivate the horn output. Inactive alarms will disappear immediately and status of active alarms will be changed to "confirmed" so they will disappear as soon as their reasons dismiss.
4		HORN RESET button. Use this button to deactivate the horn output without acknowledging the alarms.
5		MODE LEFT button. Use this button to change the mode. The button works only if the main screen with the indicator of currently selected mode is displayed. NOTE: This button will not work if the controller mode is forced by one of binary inputs Remote OFF, Remote MAN, Remote AUT.

6		<p>MODE RIGHT button. Use this button to change the mode. The button works only if the main screen with the indicator of currently selected mode is displayed.</p> <p>NOTE: This button will not work if the controller mode is forced by one of binary inputs Remote OFF, Remote MAN, Remote AUT.</p>
7		<p>GCB button. Works in MAN mode only. Press this button to open or close the GCB manually. Note that certain conditions must be valid otherwise GCB closing is blocked.</p>

GEN-SET OPERATION INDICATORS

POSITION	INDICATOR DESCRIPTION
8	<p>Gen-set failure. Red LED starts flashing when gen-set failure occurs. After FAULT RESET button is pressed, goes to steady light (if an alarm is still active) or is off (if no alarm is active).</p>
9	<p>Gen-set voltage OK. Green LED is on if the generator voltage is present and within limits.</p> <p>NOTE: The limits for the generator voltage and frequency are given by setpoints in the Gener Protect group.</p>
10	<p>GCB ON. Green LED is on, if GCB is closed. It is driven by GCB CLOSE/OPEN output (MRS 3/4/10/15) or by GCB feedback signal (MRS 11/16).</p>

DISPLAY AND CONTROL BUTTONS

POSITION	BUTTON	DESCRIPTION
11		<p>PAGE button. Use this button to switch over display pages. See Display Screens and Pages Structure chapter below this table for more details.</p>
12		<p>UP button. Use this button to move up or increase a value.</p>
13		<p>DOWN button. Use this button to move down or decrease a value.</p>
14		<p>ENTER button. Use this button to finish editing a setpoint or moving right in the history page.</p>
15		<p>Graphic B/W display, 128x64 pixels</p>

Display Screens and Pages Structure

The displayed information is structured into "pages" and "screens". Use PAGE button to switch over the pages.

1. The page *Measurement* consists of screens which display measured values like voltages, current, oil pressure etc., computed values like i.e. gen-set power, statistic data and the alarm list on the last screen.
2. The page *Setpoints* contains all setpoints organized to groups and also a special group for entering password.
3. The page *History log* shows the history log in the order that the last record is displayed first.

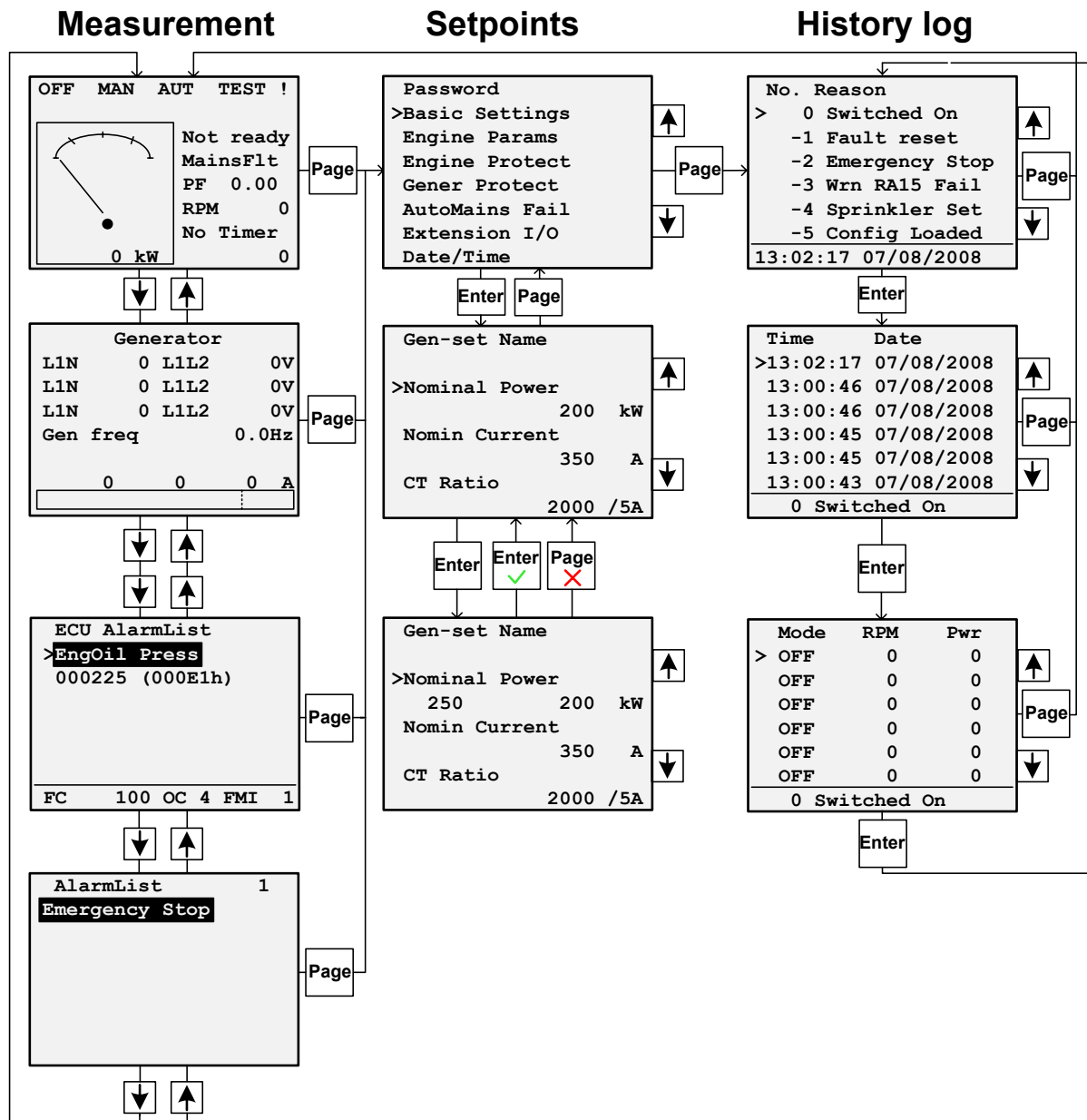

NOTE:

History and **Setpoints** pages are available only when you choose **Engineer** interface (not User). See **Controller Information Screen** subchapter below.

History Log is **not supported** in IntelliLite MRS 3, 4, 10, 11 and AMF 8, 9, 20.

Alarms

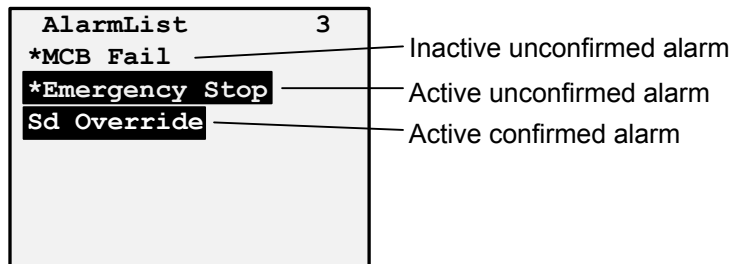

Browsing ECU Alarms

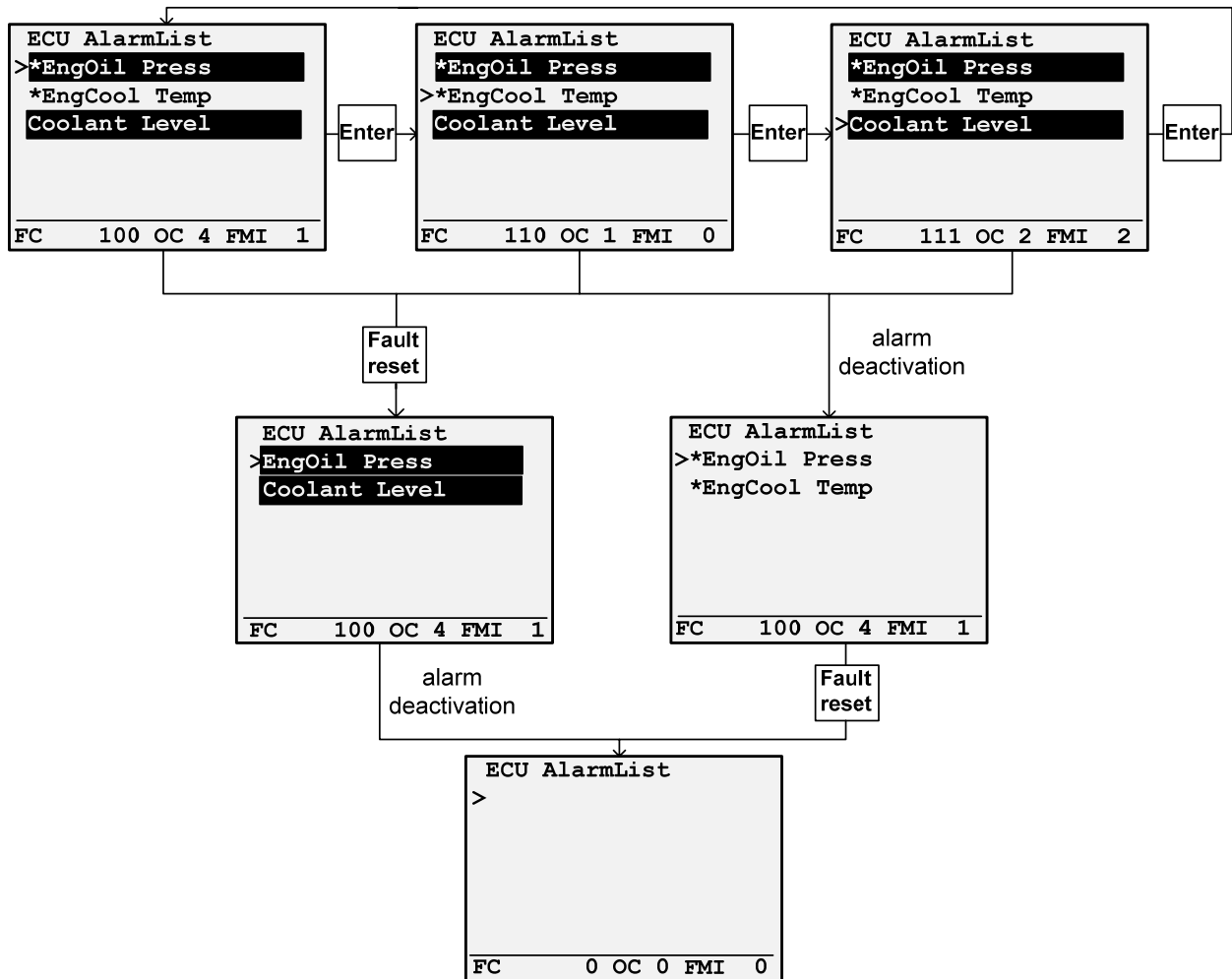

Setpoint Change

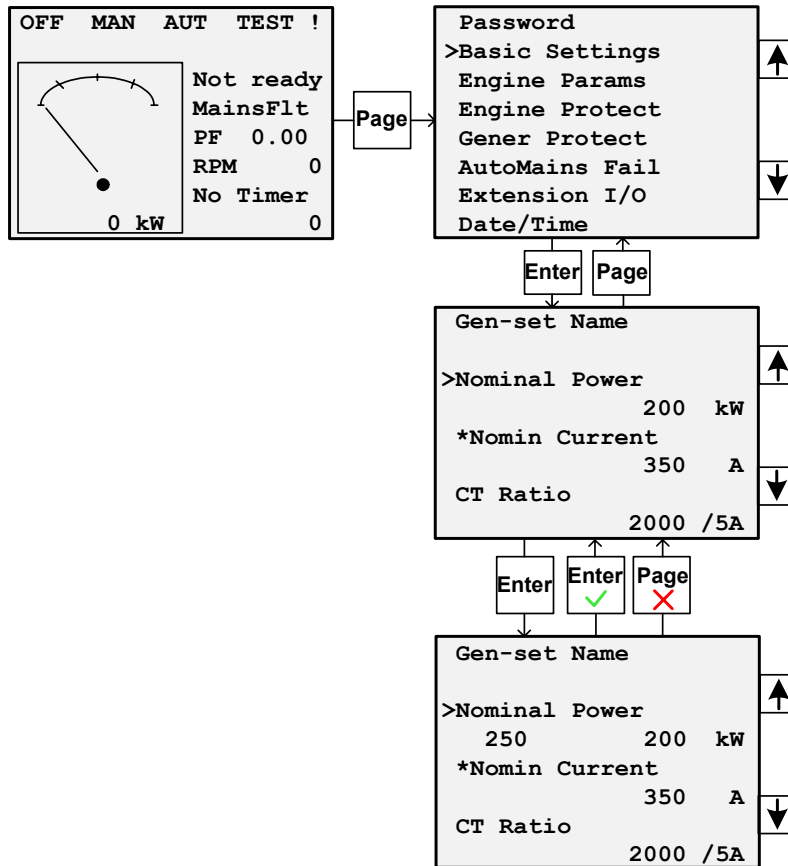

NOTE:
Cannot change setpoint?
 Setpoints marked with an asterisk are password protected. Enter password as described in the chapter *Entering the Password* below.

Entering the Password

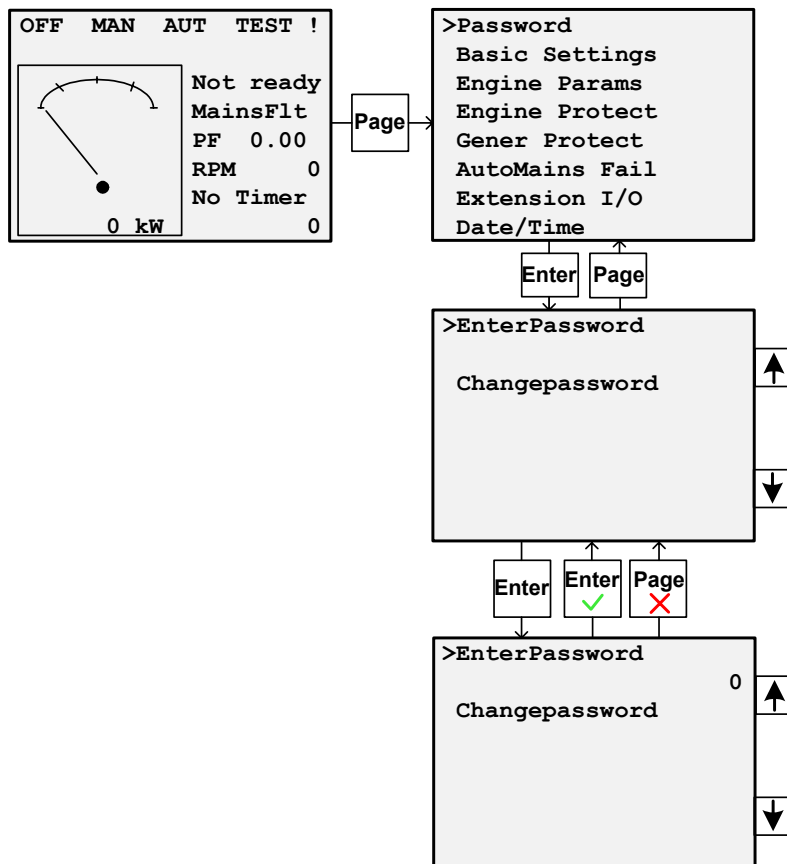

NOTE:
Lost password? Display the information screen containing the serial number and password decode number as described in the chapter below and send them to your local distributor.

Controller Information Screen

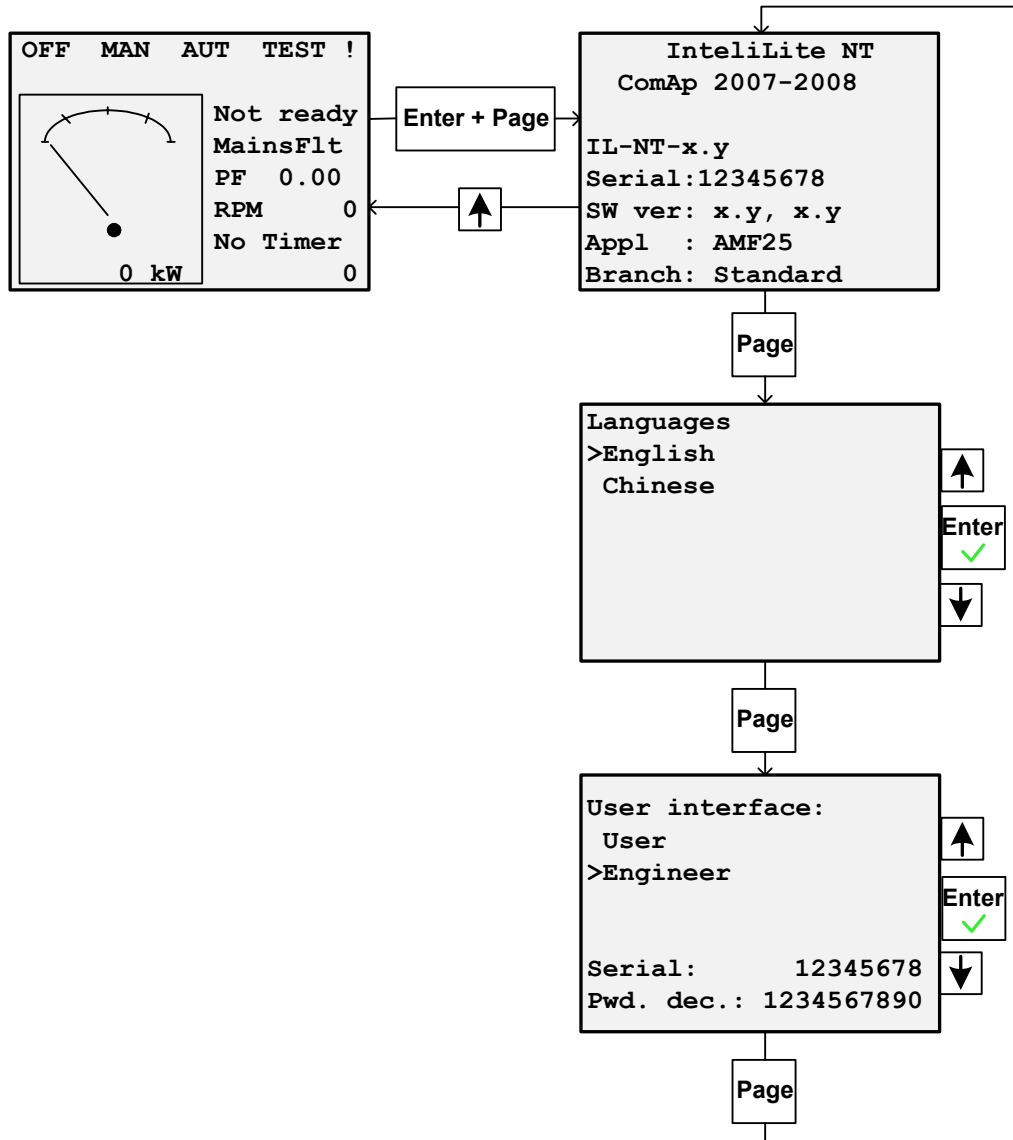

Display Contrast Adjustment

