

HYUNDAI
POWER PRODUCTS

HEDGE TRIMMER HYHT550E

Instruction Manual



GENUINE PRODUCT OF
HYUNDAI CORPORATION

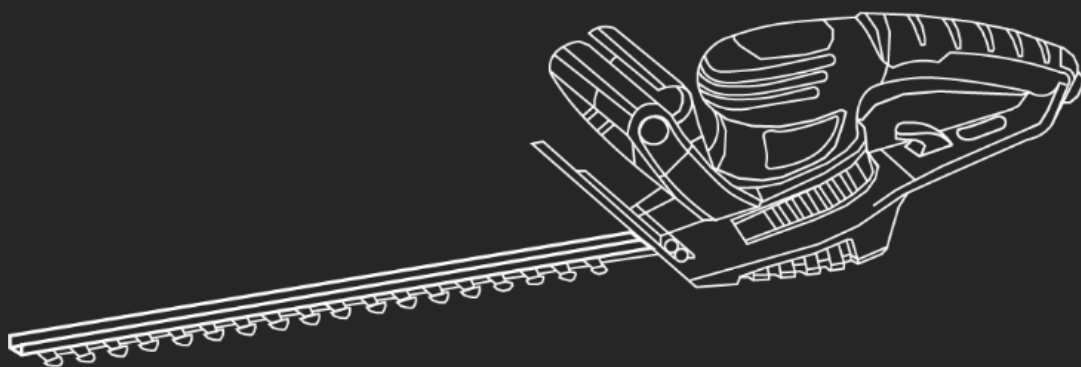

WARNING: Read the instructions carefully before use.

Iss.Oct/24

Contents

| | | | |
|---------------------------------------|--------------|--------------------------------|-----------|
| Introduction..... | 3 | Notes..... | 29 |
| Safety Information..... | 4-13 | Useful Information..... | 30 |
| Understand Your Machine..... | 4 | Our YouTube Channel..... | 30 |
| Personal Safety..... | 4-5 | Warranty..... | 30 |
| Inspect Your Machine..... | 5 | Manual Updates..... | 30 |
| Work Area..... | 6 | Returning Your Product..... | 30 |
| During Use..... | 7 | Leaving A Review..... | 30 |
| Batteries..... | 8 | Ordering Spare Parts..... | 30 |
| Electricity..... | 8-9 | | |
| Double Insulated Devices..... | 9 | Product Record..... | 31 |
| Vibrations..... | 10 | | |
| Noise..... | 10 | Contact Us..... | 32 |
| Residual Risks..... | 10 | | |
| Intended Use..... | 11 | | |
| Personal Protective Equipment..... | 12 | | |
| Symbols On The Machine..... | 13 | | |
| Unboxing..... | 14 | | |
| In The Box..... | 15 | | |
| Features..... | 16 | | |
| Assembly..... | 17-19 | | |
| Assembly Overview..... | 17 | | |
| Attach Safety Guard..... | 17 | | |
| Cable Holder On Handle..... | 18 | | |
| Remove The Blade Cover..... | 19 | | |
| Operation..... | 20-22 | | |
| Cutting Tips..... | 20 | | |
| Before Starting Work..... | 20 | | |
| Starting..... | 21 | | |
| Stopping..... | 21 | | |
| Cutting A Hedge..... | 22 | | |
| Maintenance & Care..... | 23-24 | | |
| General Maintenance..... | 23 | | |
| Storage..... | 23 | | |
| Cleaning..... | 23 | | |
| Replacement Parts/Spares Info..... | 24 | | |
| Troubleshooting..... | 25 | | |
| Specifications..... | 26 | | |
| Recycling And Disposal..... | 27 | | |
| Declaration Of Conformity..... | 28 | | |

Introduction

Thank You For Purchasing Your HYUNDAI Product

We work very hard to give all of our customers the best possible service. If you have any problems, before leaving negative feedback, please contact us to give us a chance to resolve the issue. We would be delighted if you left us positive feedback! Thank you for purchasing this product.

Important!



WARNING: READ THE INSTRUCTION BOOKLET THOROUGHLY BEFORE USING THE MACHINE. Keep for future reference and pass it on if the machine is loaned or sold to another user.

This manual has been produced by Hyundai Power Products and should be kept with the product. Please read and understand these instructions before you use your product. Failure to do this may result in personal injury or damage to the product.

The safety precautions and warnings are to ensure your safety and protect you from harm or damage to the product.

The information contained in this manual was accurate at the time of production, however HYUNDAI Power Products may make modifications to the product without notification.

Safety Information

Understand Your Machine

- **WARNING!** You must read these instructions carefully before operating the machine. Make sure that you are familiar with the controls and properly operate the machine. You must learn how to stop the machine quickly. If you do not follow the warnings and instructions, it may result in fire and/or serious injury. Make sure to save all warnings and instructions for future reference.
- Read this manual and labels affixed to the machine to understand its limitations and potential hazards.
- Be thoroughly familiar with the controls and their proper operation. Know how to stop the machine and disengage the controls quickly.
- If the unit is to be used by someone other than original purchaser, or is to be loaned, rented, or sold, always provide this manual and any needed safety training before operation. The user can prevent and is responsible for accidents or injuries that may occur to themselves, to other people, or to property.
- Do not force the machine beyond its limits. Use the correct machine for your application.
- Know how to stop the machine quickly in case of emergency. Understand the use of all controls.
- ALL MAINTENANCE other than that listed in this manual, should be carried out by professionally trained and certified personnel.
- When using this machine for the first time and before actual work, you **MUST** learn how to handle the machine from an experienced or skilled person.

Personal Safety

- **WARNING!** Never allow children or people unfamiliar with these instructions to use the product. Local regulations can restrict the minimum age of the operator.
- Keep children, pets, and other people not using the unit away from the work area (at least 15m). Be alert and shut off the unit if anyone enters work area. Keep children under the watchful care of a responsible adult.
- Stay alert, watch what you are doing and use common sense when operating the machine. Never operate the machine when unwell or tired, or if you have taken alcohol, medicine, drugs or any substances which may slow your reflexes and compromise judgment. A moment of inattention while operating the machine may result in serious personal injury.
- Appropriate Personal Protective Equipment (PPE), **MUST** be worn at all times when operating or repairing the machine. Always wear anti-slip and resistant work footwear and long trousers while using the machine. Do not use the machine when barefoot, wearing sandals or similar lightweight footwear. Do not wear chains, bracelets or clothing that is loose fitting or hanging ties or cords. Tie long hair back. Always wear protective earplugs. Loose clothes, jewellery, or long hair can be caught in moving parts. Protect eyes, face, and head from objects that may be thrown from the unit. Always wear safety goggles or safety glasses with side shields when operating.
- Always keep hands and feet away from all moving parts during operation. Moving parts can cut or crush body parts. Always keep hands and feet away from all pinch points.

Safety Information

Personal Safety (Continued)

- Do not touch parts that might be hot from operation. Allow parts to cool before attempting to maintain, adjust, or service.
- Do not overreach. Keep proper footing and balance at all times. This enables better control of the machine in unexpected situations. Extending your body too far can result in a loss of balance and you may fall which will result in injury.
- Never place any part of your body where it would be in danger if movement should occur during assembly, installation, and operation, maintenance, repairing or moving.
- Keep in mind that the operator or user is responsible for accidents, hazards or unexpected events involving the machine that occur to other people or their property. It is the responsibility of the user to assess the potential risk of the area where work is being carried out. The operator or user must take all necessary precautions to ensure their own safety and that of others, especially on slopes or rough, slippery and unstable ground.

Inspect Your Machine

- Check your machine before starting it. Keep guards in place and in working order. Make sure all nuts, bolts, etc., are securely tightened.
- You must check the general condition of the machine before use.
- Never operate the machine when it is in need of repair or is in poor mechanical condition. Replace damaged, missing, or failed parts before using it. Check for fuel leaks. Keep the machine in safe working condition.
- Do not use the machine if the machine's switch does not turn off the machine when running. Any machine that can't be controlled with the switch is dangerous and must be replaced.
- Regularly check to see that keys and adjusting wrenches are removed from the machine area before starting it. A wrench or a key that is left attached to a rotating part of the machine may result in personal injury.
- If the machine should start to vibrate abnormally, stop the machine and check immediately for the cause. Vibration is generally a warning sign of trouble.
- Avoid accidental starting. Be sure the switch is off before transporting the machine or performing any maintenance or service on the unit. Transporting or performing maintenance or service on a machine with its switch on invites accidents.
- Do not tamper with or disable safety systems.
- Only use manufacturer-recommended attachments.
- Before using, always visually inspect to see that the tools are not worn out or damaged. Replace worn out or damaged elements and bolts in set to preserve balance.
- Keep the machine in good operating condition. Operating the machine in poor or questionable condition could result in serious injury.
- Be sure all safety devices are in working order and warning labels are in place. These items are installed for your safety.

Safety Information

Work Area

- You must only work in daylight or with good artificial light in good visibility conditions. Do not work at night, at times of heavy fog, or at any other times when your field of vision might be limited and it would be difficult to gain a clear view of the area.
- Keep people, children and animals away from the working area.
- Operate on flat, level ground.
- DO NOT work on wet ground. If there has been heavy rain on the working site, wait until the ground has dried up.
- Never park the machine in a place with unstable ground which could give way.
- You must be careful near ravines, ditches or embankments.
- Exercise extreme caution when operating on or crossing gravel drives, walks, or roads. Stay alert for hidden hazards or traffic.
- Do not work in the rain, when there is a thunderstorm or lightning risk, at times of strong or gale force winds, or at any other times when the weather conditions might make it unsafe to use this product. If there is bad weather conditions, do not use the machine.
- Make sure you thoroughly inspect the entire work area and remove all objects and anything that could be thrown by the machine or could damage the machine (branches, stones, wire, toys, etc). Attempting to clear the work area whilst using the machine will reduce your concentration and creates a trip hazard. Any liquid spilled on the floor may result in you slipping.
- DO NOT operate power tools in explosive atmospheres, such as in the presence of flammable liquids, gases or dust. Power tools may create sparks, which may ignite the dust or fumes.

Safety Information

During Use

- Do not operate the machine in confined areas where there may be a risk of crushing the operator between the machine and another object.
- Never attempt to make any adjustments, while the machine is running.
- You must switch off the machine:
 - Before checking or working on the machine.
 - When transporting the machine.
 - Whenever you leave the machine unattended.
 - If the machine starts to vibrate abnormally.
- **WARNING!** If something breaks or an accident happens whilst working, you must turn off the machine immediately and move the machine away to prevent further damage. If an accident happens with injuries or third parties are injured, carry out the first aid measures most suitable for the situation immediately and contact the medical authorities for any necessary health care. Carefully remove any debris that might cause damage or harm persons or animals should it not be seen.
- After striking a foreign object, stop the machine immediately and inspect the machine thoroughly for damage. Repair the damage before continuing.
- Keep extension cord away from cutting elements.
- Never operate the machine with damaged guards or without the guard in place.
- Keep hands and feet away from the cutting means at all times especially when switching on the motor.
- Never operate the machine without the defective guards or shields, or without safety devices, or if the cord is damaged or worn.
- Metal obstacles like fences etc may damage the cutting blades.
- Always make sure that the power cord is not in the way of your work.

Safety Information

Electricity (Where Applicable)

DANGER : ELECTRICITY CAN KILL – NEVER WORK ON LIVE / ENERGISED EQUIPMENT.



- Prior to carrying out any maintenance work you **MUST** identify electrical isolation methods and isolate all electrical supplies.
- Prior to use and with all electrical supplies isolated, you **MUST** check all electrical cables, plugs and connectors for the following;
 - Are intact and have no signs of damage, to include but not limited to bare wires, chaffing, cuts and loose wiring.
 - If there are any signs of damage, the damaged item **MUST** be taken out of service until the damage has been repaired by an electrically competent person.
 - All trailing cables should be routed so as not to cause any kind of trip hazard.
 - **NEVER** work on or near electricity with wet hands, wet clothing and wet gloves.

Safety Information

Electricity (Continued)

- Power tools plug must match the outlet. Never modify the plug in any way. DO NOT use any adapter plugs with earthed (grounded) power tools. Unmodified plugs and matching outlets will reduce risk of electric shock.
- DO NOT expose this power tool to rain or wet conditions. Water entering a power tool will increase the risk of electric shock. DO NOT abuse the power cord. Never use the cord for carrying, pulling or unplugging the power tool. Keep the cord away from heat, oil and sharp edges or moving parts. Damaged or entangled cords increase the risk of electric shock. When operating a power tool, use an extension cord suitable for outdoor use. Use of a cord suitable for outdoor use reduces the risk of electric shock.
- **IMPORTANT:** Make sure that the electric circuit is fused, and that the power, voltage and frequency of the motor is supported by your mains supply. Also, make sure that your power supply is earthed. Connect your machine to earth. Never open the ON/OFF switchbox. However, if it should become necessary to do so, contact a qualified electrician. Make sure that you will never touch live contacts, specifically when you plug or unplug your machine. This machine and its power cord must never get into contact with water.
- Avoid body contact with earthed or grounded surfaces such as pipes, radiators, ranges and refrigerators. There is an increased risk of electric shock if your body is earthed or grounded.
- To prevent electric shock, use only with an extension cord suitable for outdoor use. For additional protection, the installation of a residual current device (RCD) having a rated residual operating current not exceeding 30mA is advisable.
- Before use, check that the extension cord is in good condition. When using an extension cord, make sure to use one heavy enough to carry the current your product will draw. An undersized cord will cause a drop in line voltage resulting in loss of power and overheating.
- Do not allow any part of the machine to make contact with water while it is in operation. If the appliance becomes wet while turned off, wipe dry before starting. Do not touch the appliance or its plug with wet hands or while standing in water. Wearing rubber boots offers some protection.
- Before use, check the supply and extension cord for signs of damage or aging. If the cord becomes damaged during use, disconnect the cord from the supply immediately. If the supply cord is damaged, it must be replaced by the manufacturer or a qualified person in order to avoid a hazard.

Double-Insulated Appliances

In a double-insulated appliance, two systems of insulation are provided instead of grounding. No grounding means that it is already provided on a double-insulated appliance. Servicing a double-insulated appliance requires extreme care and knowledge of the system, and should be performed only by qualified service personnel. Replacement parts for a double-insulated appliance must be identical to the parts they replace.

Safety Information

Vibrations (Where Applicable)

- Prolonged use of hand held (operated) machines will cause the user to feel the effects of/from vibrations. These vibrations can lead to white finger (Raynaud's phenomenon) or carpal tunnel syndrome. This condition reduces the ability of the hand to feel and regulate temperature, causing numbness and heat sensations and may cause nerve damage and circulatory tissue death.
- Not all factors that lead to white finger disease are known, but cold weather, smoking and other diseases that affect blood vessels and blood circulation as well as large and long-lasting impact of shocks are considered factors in the formation of white finger. Note the following to reduce the risk of white finger and carpal tunnel syndrome;
- Wear gloves and keep your hands warm.
- Take regular breaks.
- All of the above precautions may help reduce the risk of white finger disease but not rule out the carpal tunnel syndrome. Long-term and regular users are therefore recommended to observe the condition of your hands and fingers. Seek medical attention immediately if any of the above symptoms should occur.

Noise (Where Applicable)

- The operating noise of the machine can damage your hearing. When wearing protection such as earplugs or ear defenders to protect your hearing. Long-term and regular users are advised to have hearing checked regularly. Be especially vigilant and cautious when wearing ear protection because your ability to hear alarm warnings will be reduced.
- Noise emissions for this equipment is unavoidable. Carry out noisy work at approved times and for certain periods. Limit the working time to a minimum. For your personal protection and protection of people working nearby it is also advisable for them to wear hearing protection.



- See Certificate of Conformity section for Outdoor Noise declaration of conformity.

Residual Risks

Even when tool is used as prescribed it is not possible to eliminate all residual risk factors. The following hazards may arise in connection with the tool's construction and design:

1. Damage to lungs if an effective dust mask is not worn.
2. Damage to hearing if effective hearing protection is not worn.

Health defects resulting from vibration emission if the power tool is being used over longer period of time or not adequately managed and properly maintained.

▲ WARNING! This machine produces an electromagnetic field during operation. This field may under some circumstances interfere with active or passive medical implants. To reduce the risk of serious or fatal injury, we recommend persons with medical implants to consult their physician and the medical implant manufacturer before operating this machine.

Safety Information

Intended Use

The HYHT550E is an electric hedge trimmer from HYUNDAI. The HYHT550E has a blade length of 510mm and is powered by a 550W HYUNDAI motor.

This machine is a garden tool and precisely a pedestrian controlled hedge trimmer. The machine is manufactured according to the latest safety requirements. Every precaution is only effective when it is followed exactly.

Intended Use

This machine was designed and manufactured for trimming hedges, bushes and shrubs.

User Types

This machine is intended for use by consumers, i.e. non professional operators. The machine is intended for "DIY" and domestic use only.

Improper Use

Any other usage not in keeping with the above mentioned ones may be hazardous and harm persons and/or damage things.

Safety Information

Personal Protective Equipment

Appropriate Personal Protective Equipment (PPE), MUST be worn at all times when operating or repairing the machine. No protective equipment can ensure 100% protection.

When selecting PPE, make sure it's CE marked and it suits the user in terms of size, fit, etc. If more than one item of PPE is worn at the same time, make sure they can be used together, e.g. wearing safety glasses may disturb the seal of a respirator, causing air leaks.



Hand Protection Must Be Worn

Protective electrically non-conductive gloves are highly recommended when working.



Foot Protection Must Be Worn

Non-skid heavy duty footwear are highly recommended when working.



Hearing Protection Must Be Worn

Suitable safety hearing protection is recommended.



Eye Protection Must Be Worn

Always wear safety glasses/goggles and/or face shields. Everyday eyeglasses have only impact resistant lenses; they are not safety glasses/goggles.



Protective Clothing Must Be Worn

Do not wear loose clothing, gloves, scarfs, neckties or jewellery (rings, wrist watches), which can be caught in moving parts.



Head Protection Must Be Worn

Wear a safety helmet with a safety visor.













Face Shield Must Be Worn

Wear a face shield to protect your face.

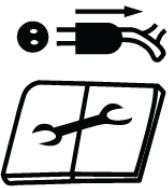
Safety Information

⚠ Symbols On The Machine

We have provided safety messages in this manual and on the machine. This information alerts you to potential hazards that could hurt you or others. Please read these messages carefully. However, we may not have listed all of the possible hazards, you must also use your own judgement.

| Symbol | Description | Symbol | Description |
|---|---|---|--|
|  | Safety alert – Indicates a precaution, a warning or a danger. |  | Disconnect the mains plug if the cord becomes damaged or entangled. |
|  | Do not expose to rain. |  | Class II tools symbol. |
|  | Disconnect the mains plug before working on the machine. |  | Sharp blades can cut limbs. |
|  | The UKCA (UK Conformity Assessed) marking is a UK product marking that is required for goods being placed on the market in Great Britain (England, Wales and Scotland). |  | Keep bystanders at a safe distance away from the work area. |
|  | This product should not be disposed of in domestic waste. Please contact your local recycling centre for disposal service. |  | This product complies with the European directives and an evaluation method of conformity for these directives was done. |
|  | Read operator's manual. | | |

Unboxing

⚠ WARNING : Unboxing and assembling the machine should be done on a flat, surface with enough room. Disposal of the packaging should be done in accordance with the local regulations in force.

⚠ WARNING : Some of the packaging material may be harmful to children. Keep out of reach of children.

1. Carefully remove the product from the packaging and examine it for any sign of damage caused during shipping.
2. Lay the contents out and check them. If any part is damaged or missing, you must not use the machine. Contact HYUNDAI POWER PRODUCTS immediately.
3. You must keep the packaging material in case the machine needs to be returned or repaired.
4. Ensure that you have all the accessories and tools you need for assembly and operation including the suitable personal protective equipment.

We recommend that you fill out the information in the 'Product Record' section. If you need to contact an authorised dealer or customer service, you may need to provide this information.

In The Box

*Not To Scale

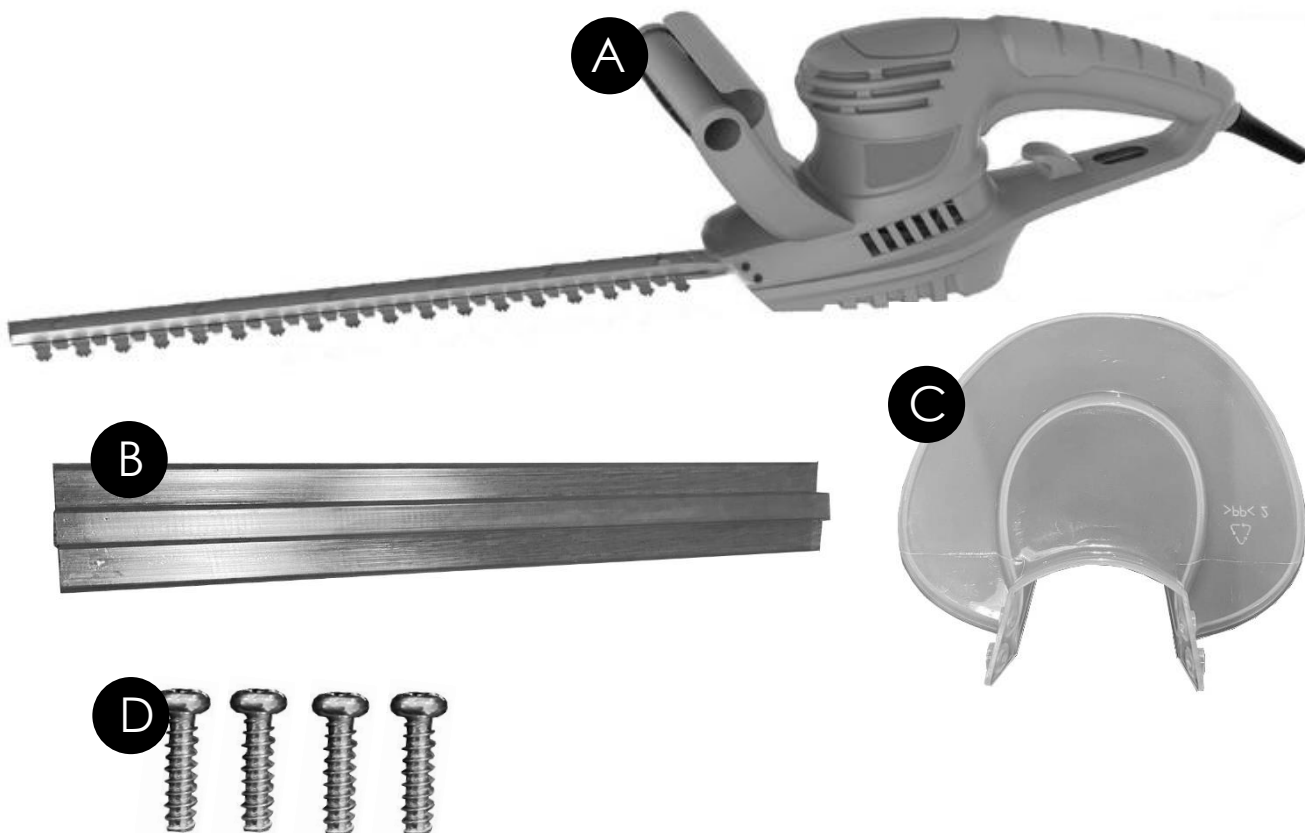

A Hedge Trimmer

B Blade Cover

Make sure you put this on the blade when transporting or storing the machine.

C Safety Guard

This may already be installed.

D 4 x Screws

Use these to attach the safety guard (C) to the hedge trimmer.

Features

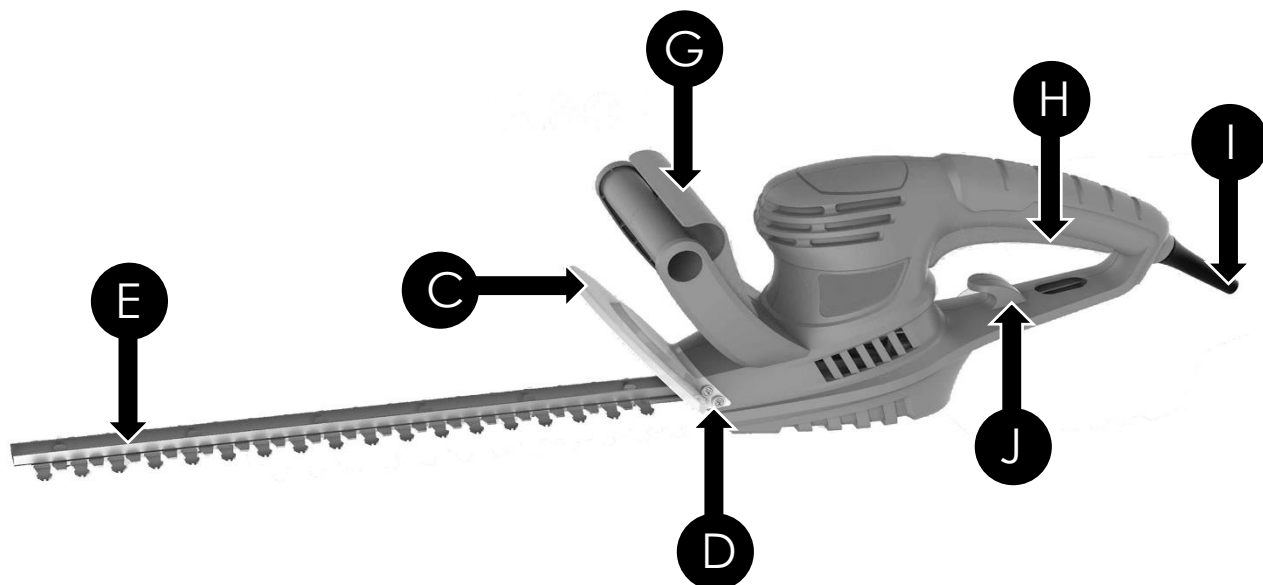

- C Safety Guard**
Keeps the users hands safe during operation (may already be installed).
- D Screws**
These keep the safety guard (**C**) in place.
- E Blade**
- G Safety Switch**
This helps prevent the trigger being pressed accidentally.
- H Trigger**
This is used for starting and stopping the machine.
- I Power Cable 10m**
- J Cable Holder**
This holds the power cable (**I**) in place while in use and prevents strain on the cable.

Assembly

⚠ You will need a Phillips screwdriver for assembly.

Assembly Overview

There are 3 steps to the assembly:

- STEP 1.** Attach The Safety Guard
- STEP 2.** Cable Holder On Handle
- STEP 3.** Remove The Blade Cover

STEP 1 : Attach The Safety Guard

⚠ DO NOT use the hedge trimmer without fitting the safety guard. It may already be installed.

1. Slot the safety guard **(C)** into place and fix securely with the screws **(D)** on both sides of the machine. There are 2 screws on each side of the machine.



Assembly

STEP 2 : Cable Holder On Handle

⚠ Make sure the machine is disconnected from power before you do this. If the machine is plugged in, you may accidentally press the trigger.

This holds the cable in place while in use and prevents strain on the cable.

1. Make a small loop in the power cable **(I)**.
2. Put the loop through the hole in the handle and on to the hook **(J)**.
3. Slowly pull the loop to remove slack.

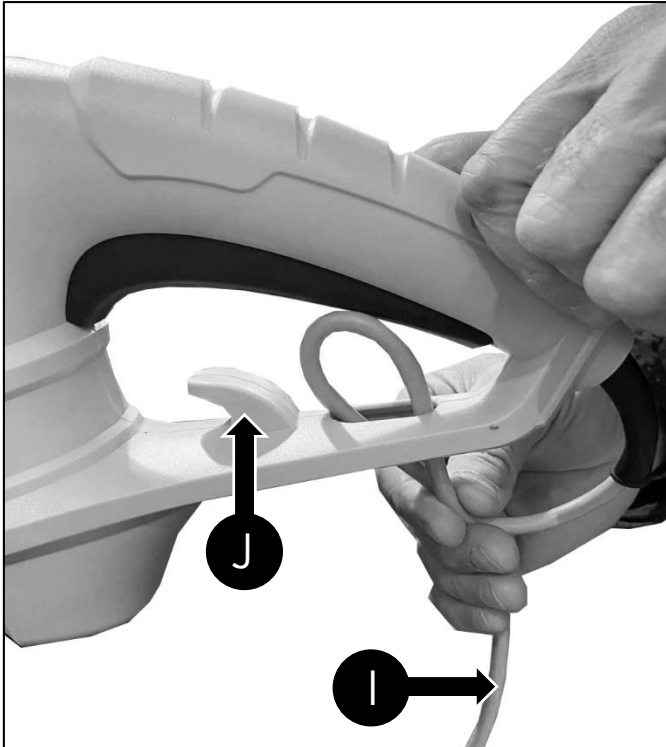

Assembly

STEP 3 : Remove The Blade Cover

1. You must remove the blade cover **(B)** before use. Be careful of the blades when doing this.
2. You can put the blade cover **(B)** back onto the blade when you are storing or transporting the machine.



Cutting Tips

⚠ When operating the hedge trimmer, keep the extension cord behind the trimmer. Never drape it over the hedge being trimmed.

- Do not force the hedge trimmer through heavy shrubbery. This can cause the blades to bind and slow down. If the blades slow down, reduce the pace.
- Do not attempt to cut stems or twigs that are too large to feed into the cutting blade. Use a non-powered hand saw or pruning saw to trim large stems.
- If blades do become jammed, stop the motor, allow the blades to stop and disconnect the plug from the power source before attempting to remove the obstruction.
- If desired, you can use a string to help cut your hedge level. Decide how high you want the hedge. Stretch a piece of string along the hedge at the desired height. Trim the hedge just above the guide line of string.
- Wear gloves when trimming thorny or prickly growth. When trimming new growth, use a wide sweeping action, so that the stems are fed directly into the cutting blade. Older growth will have thicker stems and will be trimmed easiest by using a sawing movement.
- To achieve a straight line, we recommend standing still and cutting everything within you reach before moving on. It is much harder to cut a straight line whilst you are walking.

Before Starting Work

1. Check the condition of the cable, if damaged do not use.
2. Ensure that no objects or branches are trapped into the machine.
3. Ensure the work area is tidy and free of any obstacles.
4. Never operate the machine if it is damaged in any way.
5. We recommend checking the hedge you are going to trim before starting work. Make sure there are no wires or cables inside. You should also make sure that there are no birds or animals nesting inside the hedge that you will disturb.
6. You can lay tarpaulin on the ground where you plan to trim the hedge to catch any trimmings. This will make it easier to pick up the trimmings afterwards. Make sure it is not a tripping hazard.

Operation

Starting

⚠ YOU MUST read and understand the full safety instruction manual before starting the machine.

1. Before connecting to the mains supply, always check the power is off.
2. The hedge trimmer is equipped with a two-handed safety switch. In order to power the machine on, you must press both the front handle safety switch **(G)** and the trigger **(H)**.



Stopping

⚠ WARNING : Cutting elements continue to rotate for a moment after the motor is switched off.

⚠ WARNING : Always switch off machine before placing it down.

1. Release the trigger **(H)** or the front handle safety switch **(G)** to stop the machine.
2. Unplug from the mains supply.

Cutting A Hedge

⚠ When operating the hedge trimmer, keep the extension cord behind the trimmer. Never drape it over the hedge being trimmed.

1. Cut and remove branches exceeding the cutting capacity of this product using a proper pruner before operation.
2. Always hold the product firmly with both hands on the front handle and rear handle. Never operate this product using only one hand.
3. Do not rush and do not attempt to cut too much with one stroke of the cutting device.
4. First cut both sides from the bottom cutting upwards to the top. This will prevent any of the cuttings falling into the path of the area still to be cut. **See image 1.**
5. After cutting the sides proceed to the top. Try to keep the cutting device angled at approximately 15° to the cutting surface. **See image 2.**

Image 1

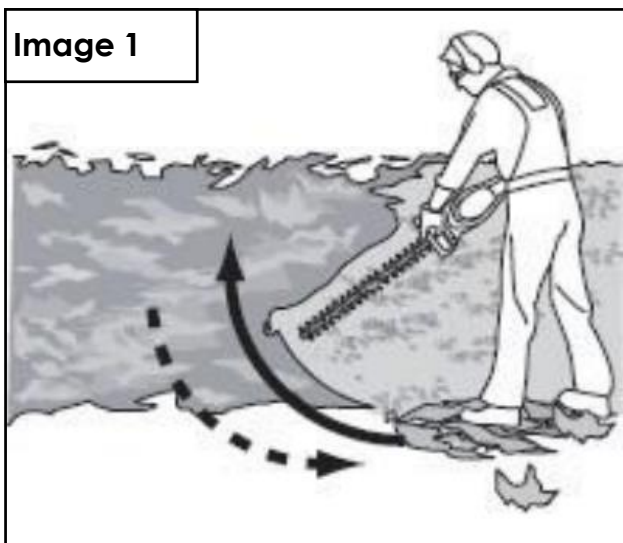
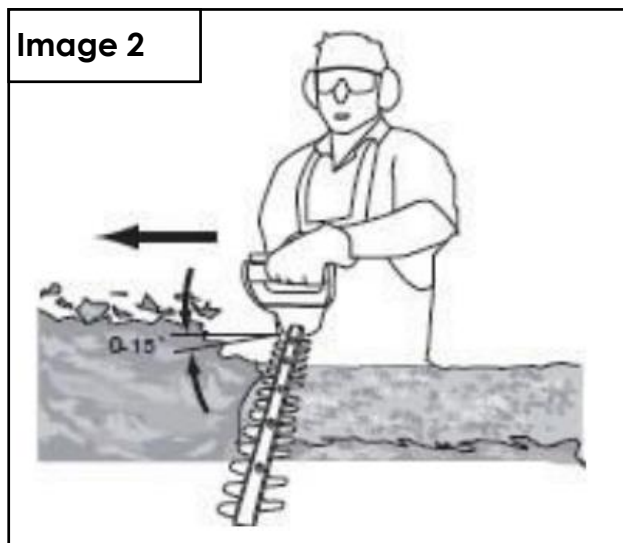

Image 2



6. When cutting wide hedges with the cutting area in sight, move the cutting blade lightly through the cutting surface in a sweeping motion, following the shape of the hedge or shrub. A slight tilt downwards of the cutting blade in the direction of motion is recommended for optimum cutting performance.
7. Cut in a number of stages if the area being cut is particularly long to achieve a better result; smaller cuttings will allow for easy composting.

NOTE: When shaping it is advisable to achieve a trapezoidal shape (**See image 3**). A trapezoidal cut corresponds to the natural growth of plants and results in optimal hedge growth, as it will expose more light to the lower end of the hedge.

Image 3

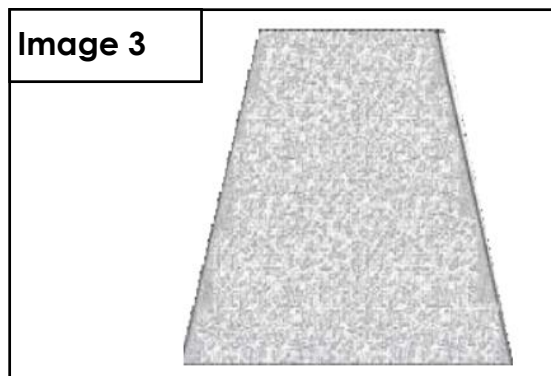

Maintenance & Care

General Maintenance

⚠ WARNING : Turn OFF the machine, allow all moving parts to come to a complete stop, and disconnect the power cord before maintaining the machine. You need to wear proper clothing and protective gloves whenever your hands are at risk.

- Keep all nuts, bolts and screws tight to be sure the machine is in a safe working condition.
- Replace worn or damaged parts for safety. Only use manufacturer-recommended parts and accessories.
- To keep your machine in good working condition, you can use spray lubricating oil along the blade, on the top of the blade, and the bottom of the blade.

Storage

⚠ Keep the machine stored in a dry, level area away from damp, moisture and rain fall. Allow the machine to cool down before storing.

- Make sure the machine is clean and dry before storing.
- Put the blade cover on the blade when in storage.
- Ensure the machine is stored in a position, where any persons cannot step on, to attempt to reach items up high, due to risk of movement.
- DO NOT store the machine near an ignition source, such as a wood stove, gas or electric heater, or an appliance or heater with a pilot light.
- Store the machine out of reach of children or anyone who is not familiar with operation.
- DO NOT stack other items on top of the machine when in storage.
- Make sure the machine is stored away from direct sunlight. Store indoors or in a safe, frost-free area during severe weather and winter months.

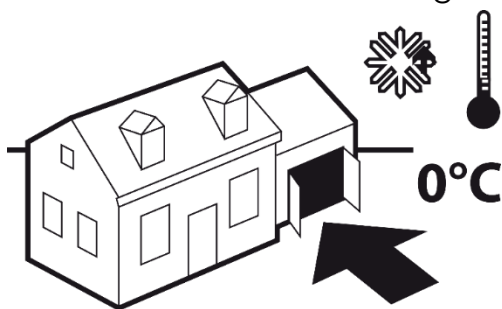

Cleaning

⚠ Always remove the electric plug from the mains supply before any cleaning is undertaken.

- Remove any grass and mud after each use to prevent it from drying. Use a clean cloth to remove dirt, grease, etc.
- DO NOT use any water on any part of the main machine.
- Avoid using solvents when cleaning plastic parts. Most plastics are susceptible to damage from various types of commercial solvents and may be damaged by their use.
- Always ensure that ventilation openings are kept clear of debris.

POWER SPARES



No Hassle Returns



Same Day Dispatch*



Over 10,000 Spare Parts



QR Code – Scan the QR code for a direct link to our website

Our Website : power-spares.co.uk

Call us : 01646 404406

Email us : sales@power-spares.co.uk

To maintain your machine in peak operating condition, proper maintenance and care are crucial. Some machines have consumable parts that will need replacement to ensure they continue operating at their full potential. Power-Spares provide manufacturer parts for all your machines, ensuring they remain in peak condition.

About Power Spares

Power-Spares has your back if you damage your lawn mower blade, find your spark plugs not sparking, or snap your recoil. Power-Spares operates under the trading name of Genpower Limited.

As part of the Genpower family, Power-Spares offers you the expertise, efficiency, and quality assurance of a large organisation. We leverage the latest warehousing, distribution, customer service, and inventory management technology to ensure you receive your parts as quickly as possible.

With extensive stock-holding of spare parts in our UK warehouses, Power-Spares is ready to assist you promptly when your machine needs repair. We're Committed to help you get back up and running as quickly as possible.

Maintenance & Care

Troubleshooting

⚠ NOTE : All corrective actions should be carried out by suitably qualified person/s.

| Problem | Possible Cause | Possible Solution |
|-----------------------------------|-----------------------------------|--|
| Machine will not start. | Fuse in mains plug blown / faulty | Check fuse in mains plug and replace is necessary. |
| | Internal wiring fault. | Contact your service dealer. |
| Machine functions intermittently. | Internal wiring fault. | Contact your service dealer. |

Technical Data

Specification

| | |
|---------------------------------------|---|
| Model | HYHT550E |
| Voltage | 230V |
| Frequency | 50Hz |
| Input Power | 550W |
| Blade Length | 510mm |
| A-Weighted Sound Pressure Level LpA | 91.09dB(A) |
| Uncertainty K | 3dB(A) |
| A-Weighted Sound Power Level LWA | 99.09dB(A) |
| Uncertainty K | 3dB(A) |
| Declaration Of The Vibration Emission | Front Handle 3.764m/s ² Rear Handle 3.498m/s ² |
| Uncertainty | K=1.5m/s ² |
| Net Weight | 3.2kg |

Recycling & Disposal

Recycling & Disposal

We do not offer a takeback scheme for the recovery of Waste Electrical Electronic Equipment (WEEE) & Batteries. Instead the responsibility to dispose of WEEE and/or Batteries is passed onto you by us.

So when it becomes necessary to dispose of your machine you must take it to your local Civic Amenity Site. For further information please contact your local Authority for disposal advice.

You **MUST** make sure that all unused oil and fuel is disposed of correctly either beforehand or at your local Civic Amenity Site.

- Under NO circumstances must any fuel or oil be put down any drains.
- Certain products contain WEEE waste which should not be disposed of in your domestic waste.
- You **MUST** recycle WEEE in accordance with your local authority or recycling centre.
- Certain products contain batteries which should not be disposed of in your domestic waste.
- You **MUST** recycle batteries in accordance with your local authority or recycling centre.
- Unwanted packaging and materials should be stored and taken to a recycling centre so it can be disposed of in a manner which is compatible with the environment.

We are a Member of the VALPAK National Compliance Scheme and our registration number is RM08660. For further information about disposal please contact your Local Authority.

You can also get more advice and guidance about recycling at the following website <http://www.recycle-more.co.uk>

Should you pass this product on to another user either sold or loaned, you **MUST** pass on this user manual. This will make sure that all other users can use and maintain this machine safely.

Environmental Protection

1. Environmental protection should be a priority of considerable importance when using the machine, for the benefit of both social coexistence and the environment in which we live. Try not to cause any disturbance to the surrounding area.
2. You must comply with local regulations and provisions for the disposal of packaging, oils, fuel, filters, damaged parts or any elements which have a strong impact on the environment. This waste must not be disposed of as normal waste. It needs to be separated and taken to specified waste disposal centres where the material will be recycled.
3. You must comply with local regulations for the disposal of waste materials after mowing.
4. When disposing, do not pollute the environment with the machine, but hand it over to a disposal centre, in accordance with the local laws in force.

EU Declaration Of Conformity

Importer and Authorised Representative

Genpower Ltd
Isaac Way, Pembroke Dock, SA72 4RW
Country of Origin: China
Description: 550W Hedge Trimmer
SKU Code: HYHT550E
Date of Issue: 18/03/2021

Regulations and Directives of Compliance

- 2006/42/EC The Machine Directive
- 2014/30/EU EMC Directive
- 2000/14/EC Noise Emissions
- 2011/65/EU RoHS

REFERENCES TO THE RELEVANT HARMONISED SAFETY STANDARDS USED OR REFERENCES TO THE OTHER TECHNICAL SPECIFICATIONS IN RELATION TO WHICH CONFORMITY IS DECLARED:

EN 62841-1:2015+A11 Electric motor-operated hand-held tools, transportable tools and lawn and garden machinery - Safety - Part 1: general requirements
EN 62841-4-2:2019/A11 Electric motor-operated hand-held tools, transportable tools and lawn and garden machinery - Safety - Part 4-2: Particular requirements for hedge trimmers
EN IEC 55014-1:2021 Electromagnetic compatibility. Requirements for household appliances, electric tools and similar apparatus. Emission
EN IEC 55014-2:2021 Electromagnetic compatibility. Requirements for household appliances, electric tools and similar apparatus. Immunity
EN IEC 61000-3-2:2019+A1 Electromagnetic compatibility (EMC). Limits. Limits for harmonic current emissions (equipment input current ≤ 16 A per phase)

Statement of Declaration

We the importer and authorised representative of the product described confirm conformity within the provisions of applicable regulations and directives listed within this document.

Signed on Behalf of Genpower Ltd

Place of Issue: Genpower Ltd

Signatory Name: Roland Llewellyn

Position: Managing Director

R J Llewellyn



Notes

Useful Information

Check Out Our YouTube Channel

Our videos on YouTube include:

- Unboxing
- Assembly of your machine
- How to service your machine
- Products in use
- 'How To' videos
- Product features

Go to YouTube and search '**Hyundai Power Products**'.

Warranty

Proof of purchase will be required before you make a warranty claim. Full warranty terms and conditions can be found on the HYUNDAI POWER PRODUCTS website:

www.hyundaipowerproducts.co.uk

Manual Updates

Our manuals are constantly being reviewed and updated. Should you find an error, omission or something unclear, please contact us for assistance. We reserve the right to make any modifications without prior notice whenever necessary. Our latest manuals are also placed online. All our manuals can be downloaded at:
www.hyundaipowerproducts.co.uk

Returning Your Product

If you are returning your product, please contact the dealer for their returns policy.

Leaving A Review

We work very hard to give all of our customers the best possible service. If you have any problems, before leaving negative feedback, please contact us to give us a chance to resolve the issue. We would be delighted if you left us positive feedback! To leave a review, please go to:

uk.trustpilot.com/review/hyundaipowerequipment.co.uk

Ordering Spare Parts

You can find the spare part you are looking for at **power-spares.co.uk**

Product Record

Information

As soon as you have purchased the machine, we recommend that you fill out the following. If you need to contact an authorised dealer or customer service for information on servicing, you may need to provide the following information.

Date Of Purchase:.....

Dealer Name:.....

Dealer Phone:.....

Model Number:.....

Serial/Batch Number:.....

Contact Us

Need Help? Talk To Our Experts

Our friendly aftersales team will be more than happy to help you.



Phone

Call our team on 01646 687 880



Email

aftersales@hyundaipowerproducts.co.uk



Online Live Chat

Go to www.hyundaipowerproducts.co.uk



Post

Genpower Ltd, Isaac Way, Pembroke Dock, Pembrokeshire, SA72 4RW.



Hyundai Support Website

Go to hyundaisupport.co.uk

HYUNDAI

POWER PRODUCTS



GENUINE PRODUCT OF
HYUNDAI CORPORATION

For Inquiries, Please Contact:
GENPOWER LTD
Isaac Way, London Road,
Pembroke Dock, UK, SA72 4RW.
T: +44 (0) 1646 687 880
E: info@hyundaipowerproducts.co.uk
www.hyundaipowerproducts.co.uk