

**HYUNDAI**  
POWER PRODUCTS

# 3000W Garden Shredder HYSH3000E

Instruction Manual



GENUINE PRODUCT OF  
HYUNDAI CORPORATION

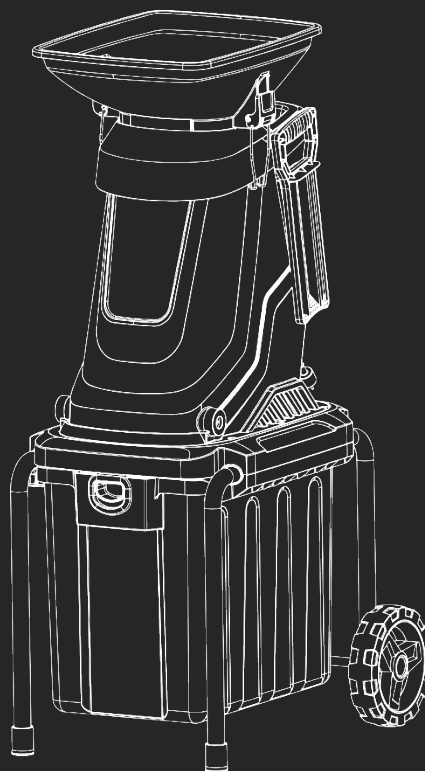

WARNING: Read the instructions carefully before use.

Iss:Oct/25

# Contents

<b>Introduction.....</b>	<b>3</b>	<b>Recycling And Disposal.....</b>	<b>31</b>
<b>Safety Information.....</b>	<b>4-14</b>	<b>Declaration Of Conformity.....</b>	<b>32</b>
Understand Your Machine.....	4	<b>Notes.....</b>	<b>33-34</b>
Personal Safety.....	4-5	<b>Useful Information.....</b>	<b>35</b>
Inspect Your Machine.....	5-6	Our YouTube Channel.....	35
Work Area.....	6	Warranty.....	35
During Use.....	7-8	Manual Updates.....	35
Electricity.....	9-10	Returning Your Product.....	35
Double Insulated Devices.....	10	Leaving A Review.....	35
Vibrations.....	11	Ordering Spare Parts.....	35
Noise.....	11	<b>Product Record.....</b>	<b>36</b>
Residual Risks.....	11	<b>Contact Us.....</b>	<b>37</b>
Intended Use.....	12		
Personal Protective Equipment.....	13		
Symbols On The Machine.....	14		
<b>Unboxing.....</b>	<b>15</b>		
<b>In The Box.....</b>	<b>16</b>		
<b>Features.....</b>	<b>17</b>		
<b>Assembly.....</b>	<b>18-20</b>		
Assembly Overview.....	18		
Attaching Wheels To Support Legs..	18-19		
Attach Collection Box To Main Unit.....	20		
Attach Hopper To The Main Unit.....	21		
<b>Operation.....</b>	<b>22-24</b>		
Before Starting.....	22		
Starting Procedure.....	22		
Stopping Procedure.....	22		
Restart Procedure.....	23		
Using The Paddle.....	24		
<b>Maintenance &amp; Care.....</b>	<b>25-29</b>		
General Maintenance.....	25		
Cleaning.....	25		
Blade Replacement.....	26		
Storage.....	27		
Replacement Parts/Spares.....	28		
Troubleshooting.....	29		
<b>Specifications.....</b>	<b>30</b>		

# Introduction

## Thank You For Purchasing Your HYUNDAI Product

We work very hard to give all of our customers the best possible service. If you have any problems, before leaving negative feedback, please contact us to give us a chance to resolve the issue. We would be delighted if you left us positive feedback! Thank you for purchasing this product.

### Important!



**WARNING: READ THE INSTRUCTION BOOKLET THOROUGHLY BEFORE USING THE MACHINE.** Keep for future reference and pass it on if the machine is loaned or sold to another user.

This manual has been produced by Hyundai Power Products and should be kept with the product. Please read and understand these instructions before you use your product. Failure to do this may result in personal injury or damage to the product.

The safety precautions and warnings are to ensure your safety and protect you from harm or damage to the product.

The information contained in this manual was accurate at the time of production, however HYUNDAI Power Products may make modifications to the product without notification.

# Safety Information

## **Understand Your Machine**

- **WARNING!** You must read these instructions carefully before operating the machine. Make sure that you are familiar with the controls and properly operate the machine. You must learn how to stop the machine quickly. If you do not follow the warnings and instructions, it may result in fire and/or serious injury. Make sure to save all warnings and instructions for future reference.
- Read this manual and labels affixed to the machine to understand its limitations and potential hazards.
- Be thoroughly familiar with the controls and their proper operation. Know how to stop the machine and disengage the controls quickly.
- If the unit is to be used by someone other than original purchaser, or is to be loaned, rented, or sold, always provide this manual and any needed safety training before operation. The user can prevent and is responsible for accidents or injuries that may occur to themselves, to other people, or to property.
- Do not force the machine beyond its limits. Use the correct machine for your application.
- Know how to stop the machine quickly in case of emergency. Understand the use of all controls.
- ALL MAINTENANCE other than that listed in this manual, should be carried out by professionally trained and certified personnel.
- When using this machine for the first time and before actual work, you **MUST** learn how to handle the machine from an experienced or skilled person.

## **Personal Safety**

- **WARNING!** Never allow children or people unfamiliar with these instructions to use the product. Local regulations can restrict the minimum age of the operator.
- Keep children, pets, and other people not using the unit away from the work area (at least 15m). Be alert and shut off the unit if anyone enters work area. Keep children under the watchful care of a responsible adult.
- Stay alert, watch what you are doing and use common sense when operating the machine. Never operate the machine when unwell or tired, or if you have taken alcohol, medicine, drugs or any substances which may slow your reflexes and compromise judgment. A moment of inattention while operating the machine may result in serious personal injury.
- Appropriate Personal Protective Equipment (PPE), **MUST** be worn at all times when operating or repairing the machine. Always wear anti-slip and resistant work footwear and long trousers while using the machine. Do not use the machine when barefoot, wearing sandals or similar lightweight footwear. Do not wear chains, bracelets or clothing that is loose fitting or hanging ties or cords. Tie long hair back. Always wear protective earplugs. Loose clothes, jewellery, or long hair can be caught in moving parts. Protect eyes, face, and head from objects that may be thrown from the unit. Always wear safety goggles or safety glasses with side shields when operating.
- Always keep hands and feet away from all moving parts during operation. Moving parts can cut or crush body parts. Always keep hands and feet away from all pinch points.

# Safety Information

## **Personal Safety (Continued)**

- Do not touch parts that might be hot from operation. Allow parts to cool before attempting to maintain, adjust, or service.
- Do not overreach. Keep proper footing and balance at all times. This enables better control of the machine in unexpected situations. Extending your body too far can result in a loss of balance and you may fall which will result in injury.
- Never place any part of your body where it would be in danger if movement should occur during assembly, installation, and operation, maintenance, repairing or moving.
- Keep in mind that the operator or user is responsible for accidents, hazards or unexpected events involving the machine that occur to other people or their property. It is the responsibility of the user to assess the potential risk of the area where work is being carried out. The operator or user must take all necessary precautions to ensure their own safety and that of others, especially on slopes or rough, slippery and unstable ground.
- This appliance is not intended for use by persons (including children) with reduced physical, sensory or mental capabilities, or lack of experience and knowledge, unless they have been given supervision or instruction concerning use of the appliance by a person responsible for their safety.

## **Inspect Your Machine**

- Check your machine before starting it. Keep guards in place and in working order. Make sure all nuts, bolts, etc, are securely tightened.
- You must check the general condition of the machine before use.
- Never operate the machine when it is in need of repair or is in poor mechanical condition. Replace damaged, missing, or failed parts before using it. Keep the machine in safe working condition.
- Do not use the machine if the machine's switch does not turn off the machine when running. Any machine that can't be controlled with the switch is dangerous and must be replaced.
- Regularly check to see that keys and adjusting wrenches are removed from the machine area before starting it. A wrench or a key that is left attached to a rotating part of the machine may result in personal injury.
- If the machine should start to vibrate abnormally, stop the machine and check immediately for the cause. Vibration is generally a warning sign of trouble.
- Avoid accidental starting. Be sure the switch is off before transporting the machine or performing any maintenance or service on the unit. Transporting or performing maintenance or service on a machine with its switch on invites accidents.
- Do not tamper with or disable safety systems.
- Only use manufacturer-recommended attachments.
- Before using, always visually inspect to see that the tools are not worn out or damaged. Replace worn out or damaged elements and bolts in set to preserve balance.

# Safety Information

## **Inspect Your Machine (Continued)**

- Keep the machine in good operating condition. Operating the machine in poor or questionable condition could result in serious injury.
- Be sure all safety devices are in working order and warning labels are in place. These items are installed for your safety.

## **Work Area**

- You must only work in daylight or with good artificial light in good visibility conditions. Do not work at night, at times of heavy fog, or at any other times when your field of vision might be limited and it would be difficult to gain a clear view of the area.
- Keep people, children and animals away from the working area where ejected material may cause injury.
- Operate on flat, level ground.
- DO NOT work on wet ground. If there has been heavy rain on the working site, wait until the ground has dried up.
- Never park the machine in a place with unstable ground which could give way.
- You must be careful near ravines, ditches or embankments.
- Exercise extreme caution when operating on or crossing gravel drives, walks, or roads. Stay alert for hidden hazards or traffic.
- Do not work in the rain, when there is a thunderstorm or lightning risk, at times of strong or gale force winds, or at any other times when the weather conditions might make it unsafe to use this product. If there is bad weather conditions, do not use the machine.
- Make sure you thoroughly inspect the entire work area and remove all objects/debris that could impede operation. Attempting to clear the work area whilst using the machine will reduce your concentration and creates a trip hazard. Any liquid spilled on the floor may result in you slipping.
- DO NOT operate power tools in explosive atmospheres, such as in the presence of flammable liquids, gases or dust. Power tools may create sparks, which may ignite the dust or fumes.
- This machine is only for outdoor use.

# Safety Information

## During Use

- Do not operate the machine in confined areas where there may be a risk of crushing the operator between the machine and another object.
- Never attempt to make any adjustments, while the machine is running.
- You must switch off the machine:
  - Before checking or working on the machine.
  - Before clearing blockages.
  - When transporting the machine.
  - Whenever you leave the machine unattended.
  - If the machine starts to vibrate abnormally.
- **WARNING!** If something breaks or an accident happens whilst working, you must turn off the machine immediately and move the machine away to prevent further damage. If an accident happens with injuries or third parties are injured, carry out the first aid measures most suitable for the situation immediately and contact the medical authorities for any necessary health care. Carefully remove any debris that might cause damage or harm persons or animals should it not be seen.
- After striking a foreign object, stop the machine immediately and inspect the machine thoroughly for damage. Repair the damage before continuing.
- Never operate the machine with damaged guards or without the guard in place.
- Keep face and body away from the feeding chute. Exercise extreme care when feeding material into the chute.
- Hands, other parts of the body or clothing must NOT be placed in the feeder, the ejection channel or near moving parts/cutting blades.
- Never operate the machine without the defective guards or shields, or without safety devices.
- Be cautious when pulling the machine towards you.
- Only remove clogged up debris from the machine once the machine has been unplugged and the blades have stopped rotating.
- Always keep your hands and feet away from the rotating parts. There is danger of serious injury.
- If the shredder vibrates or emits unusual noises when switched on, release the ON/OFF trigger and do not use.
- Do not tilt the machine when starting, or during operation.
- Make sure you always remain a safe distance away from the ejection opening.
- When feeding material into the device, be extremely careful not to insert metal pieces, stones, bottles, cans and/or other foreign objects.
- Switch the motor off before moving the shredder from one area to another. Wait for the moving parts to come to a complete stop.
- When feeding material, never stand on a level higher than the base of the device.
- **DO NOT** allow processed material to accumulate in the ejection area as this may prevent proper ejection and cause the material to bounce back through the feed opening.
- Never remove the collection bag when the machine is being operated.
- Never touch under the housing body when the machine is running. Allow ample time for the machine to cool down before performing cleaning/maintenance, or when transporting it back to its storage area.

# Safety Information

## During Use (Continued)

- Before starting the machine, make sure that the feeder is empty.
- **WARNING!** This power tool generates an electromagnetic field during operation. Under certain circumstances, this field may affect active or passive medical implants. To reduce the risk of serious or fatal injury, we recommend that individuals with medical implants consult your physician and the manufacturer of the medical implant before operating the machine.
- Always stand clear of the discharge zone when operating the machine.
- If the machine becomes clogged, shut off the power source and disconnect from power supply before clearing debris. Keep the power source clear of debris and other accumulations to prevent damage to the power source or possible fire.
- **DO NOT** transport the machine whilst connected to a live power source.
- **DO NOT** fill soft waste such as kitchen rubbish into the shredder.
- **DO NOT** insert material too big for the shredder to process.
- **DO NOT** exceed the shredder's collection bag limit. This can lead to debris being ejected back up through the inlet chute.
- To make finer compost, the shredded material can be processed for a second time.
- Organic material contains a large amount of water and sap that could stick to the shredder. To avoid this, the material should be left for a few days to dry out. However, large branches are best shredded when they are fresh.
- If during cutting the blade stalls, stop the shredder immediately and disconnect it from the mains supply before investigating the cause. Remove jammed debris from the blades and examine them for any damage before starting shredding again.

**NOTE: When operating the shredder to process fibrous or woody garden waste, we recommend that you wear a face mask suitable to protect against wood dust.**

# Safety Information

## Electricity (Where Applicable)

**DANGER : ELECTRICITY CAN KILL – NEVER WORK ON LIVE / ENERGISED EQUIPMENT.**



- Prior to carrying out any maintenance work you **MUST** identify electrical isolation methods and isolate all electrical supplies.
- Prior to use and with all electrical supplies isolated, you **MUST** check all electrical cables, plugs and connectors for the following;
  - Are intact and have no signs of damage, to include but not limited to bare wires, chaffing, cuts and loose wiring.
  - If there are any signs of damage, the damaged item **MUST** be taken out of service until the damage has been repaired by an electrically competent person.
  - All trailing cables should be routed so as not to cause any kind of trip hazard.
  - **NEVER** work on or near electricity with wet hands, wet clothing and wet gloves.
- Power tools plug must match the outlet. Never modify the plug in any way. **DO NOT** use any adapter plugs with earthed (grounded) power tools. Unmodified plugs and matching outlets will reduce risk of electric shock.
- **DO NOT** expose this power tool to rain or wet conditions. Water entering a power tool will increase the risk of electric shock. **DO NOT** abuse the power cord. Never use the cord for carrying, pulling or unplugging the power tool. Keep the cord away from heat, oil and sharp edges or moving parts. Damaged or entangled cords increase the risk of electric shock. When operating a power tool, use an extension cord suitable for outdoor use. Use of a cord suitable for outdoor use reduces the risk of electric shock.
- **IMPORTANT:** Make sure that the electric circuit is fused, and that the power, voltage and frequency of the motor is supported by your mains supply. Also, make sure that your power supply is earthed. Connect your machine to earth. Never open the ON/OFF switchbox. However, if it should become necessary to do so, contact a qualified electrician. Make sure that you will never touch live contacts, specifically when you plug or unplug your machine. This machine and its power cord must never get into contact with water.
- Avoid body contact with earthed or grounded surfaces such as pipes, radiators, ranges and refrigerators. There is an increased risk of electric shock if your body is earthed or grounded.

# Safety Information

## **Electricity (Continued)**

- To prevent electric shock, use only with an extension cord suitable for outdoor use. For additional protection, the installation of a residual current device (RCD) having a rated residual operating current not exceeding 30mA is advisable.
- Before use, check that the extension cord is in good condition. When using an extension cord, make sure to use one heavy enough to carry the current your product will draw. An undersized cord will cause a drop in line voltage resulting in loss of power and overheating.
- Do not allow any part of the machine to make contact with water while it is in operation. If the appliance becomes wet while turned off, wipe dry before starting. Do not touch the appliance or its plug with wet hands or while standing in water. Wearing rubber boots offers some protection.
- Before use, check the supply and extension cord for signs of damage or aging. If the cord becomes damaged during use, disconnect the cord from the supply immediately. If the supply cord is damaged, it must be replaced by the manufacturer or a qualified person in order to avoid a hazard.

## **Double-Insulated Appliances**

In a double-insulated appliance, two systems of insulation are provided instead of grounding. No grounding means that it is already provided on a double-insulated appliance. Servicing a double-insulated appliance requires extreme care and knowledge of the system, and should be performed only by qualified service personnel. Replacement parts for a double-insulated appliance must be identical to the parts they replace.

# Safety Information

## Vibrations (Where Applicable)

- Prolonged use of hand held (operated) machines will cause the user to feel the effects of/from vibrations. These vibrations can lead to white finger (Raynaud's phenomenon) or carpal tunnel syndrome. This condition reduces the ability of the hand to feel and regulate temperature, causing numbness and heat sensations and may cause nerve damage and circulatory tissue death.
- Not all factors that lead to white finger disease are known, but cold weather, smoking and other diseases that affect blood vessels and blood circulation as well as large and long-lasting impact of shocks are considered factors in the formation of white finger. Note the following to reduce the risk of white finger and carpal tunnel syndrome;
- Wear gloves and keep your hands warm.
- Take regular breaks.
- All of the above precautions may help reduce the risk of white finger disease but not rule out the carpal tunnel syndrome. Long-term and regular users are therefore recommended to observe the condition of your hands and fingers. Seek medical attention immediately if any of the above symptoms should occur.

## Noise (Where Applicable)

- The operating noise of the machine can damage your hearing. When wearing protection such as ear plugs or ear defenders to protect your hearing. Long-term and regular users are advised to have hearing checked regularly. Be especially vigilant and cautious when wearing ear protection because your ability to hear alarm warnings will be reduced.
- Noise emissions for this equipment is unavoidable. Carry out noisy work at approved times and for certain periods. Limit the working time to a minimum. For your personal protection and protection of people working nearby it is also advisable for them to wear hearing protection.



- See Certificate of Conformity section for Outdoor Noise declaration of conformity.

## Residual Risks

Even when tool is used as prescribed it is not possible to eliminate all residual risk factors. The following hazards may arise in connection with the tool's construction and design:

1. Damage to lungs if an effective dust mask is not worn.
2. Damage to hearing if effective hearing protection is not worn.

Health defects resulting from vibration emission if the power tool is being used over longer period of time or not adequately managed and properly maintained.

** WARNING!** This machine produces an electromagnetic field during operation. This field may under some circumstances interfere with active or passive medical implants. To reduce the risk of serious or fatal injury, we recommend persons with medical implants to consult their physician and the medical implant manufacturer before operating this machine.

# Safety Information

## Intended Use

The HYSH3000E is a corded-electric 3000W garden shredder from HYUNDAI.

### **Intended Use**

This machine is designed exclusively for shredding fibrous or woody garden waste such as hedge and tree trimmings, branches, bark or fir cones.

This machine must NOT be filled with stones, glass, metal, bones, plastics, material waste or any foreign object that can cause damage to the blades.

**Failure to adhere to the operating and safety procedures explained in this manual can damage the machine and lead to the risk of serious injury.**

### **User Types**

This machine is intended for use by consumers, i.e. non professional operators. The machine is intended for "DIY" and domestic use only.

### **Improper Use**

Any other usage not in keeping with the above mentioned ones may be hazardous and harm persons and/or damage things. Examples of improper use may include, but are not limited to:

- Transporting people, children or animals on the machine
- Using the machine to tow or push loads
- Using the machine on any unsuitable surfaces

# Safety Information

## Personal Protective Equipment

**Appropriate Personal Protective Equipment (PPE), MUST be worn at all times when operating or repairing the machine. No protective equipment can ensure 100% protection.**

When selecting PPE, make sure it's CE marked and it suits the user in terms of size, fit, etc. If more than one item of PPE is worn at the same time, make sure they can be used together, e.g. wearing safety glasses may disturb the seal of a respirator, causing air leaks.



### **Hand Protection Must Be Worn**

Protective electrically non-conductive gloves are highly recommended when working.



### **Foot Protection Must Be Worn**

Non-skid heavy duty footwear are highly recommended when working.



### **Hearing Protection Must Be Worn**

Suitable safety hearing protection is recommended.



### **Eye Protection Must Be Worn**

Always wear safety glasses/goggles and/or face shields. Everyday eyeglasses have only impact resistant lenses; they are not safety glasses/goggles.



### **Protective Clothing Must Be Worn**

Do not wear loose clothing, gloves, scarfs, neckties or jewellery (rings, wrist watches), which can be caught in moving parts.



### **Head Protection Must Be Worn**

Wear a safety helmet with a safety visor.











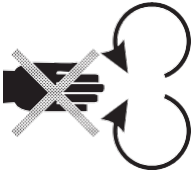

### **Face Shield Must Be Worn**

Wear a face shield to protect your face.

# Safety Information

## ! Symbols On The Machine

We have provided safety messages in this manual and on the machine. This information alerts you to potential hazards that could hurt you or others. Please read these messages carefully. However, we may not have listed all of the possible hazards, you must also use your own judgement.

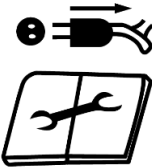
Symbol	Description	Symbol	Description
	Safety alert – Indicates a precaution, a warning or a danger.		Disconnect the mains plug if the cord becomes damaged or entangled.
	Do not expose to rain.		The rotating parts are capable of amputating fingers, toes and feet. Failure to observe could result in serious injury or death.
	Wear hearing protection.		Wear eye protection.
	Read operator's manual.		Keep bystanders at a safe distance away from the work area.
	This product should not be disposed of in domestic waste. Please contact your local recycling centre for disposal service.		This product complies with the European directives and an evaluation method of conformity for these directives was done.
	Keep hands away from all cutting edges and moving parts. Fingers can be cut or crushed.		Guaranteed sound power level.
	Switch off and unplug the device before cleaning or performing maintenance on it.		

# Unboxing

**⚠ WARNING** : Unboxing and assembling the machine should be done on a flat, surface with enough room. Disposal of the packaging should be done in accordance with the local regulations in force.

**⚠ WARNING** : Some of the packaging material may be harmful to children. Keep out of reach of children.

1. Carefully remove the product from the packaging and examine it for any sign of damage caused during shipping.
2. Lay the contents out and check them. If any part is damaged or missing, you must not use the machine. Contact HYUNDAI POWER PRODUCTS immediately.
3. You must keep the packaging material in case the machine needs to be returned or repaired.
4. Ensure that you have all the accessories and tools you need for assembly and operation including the suitable personal protective equipment.

# In The Box

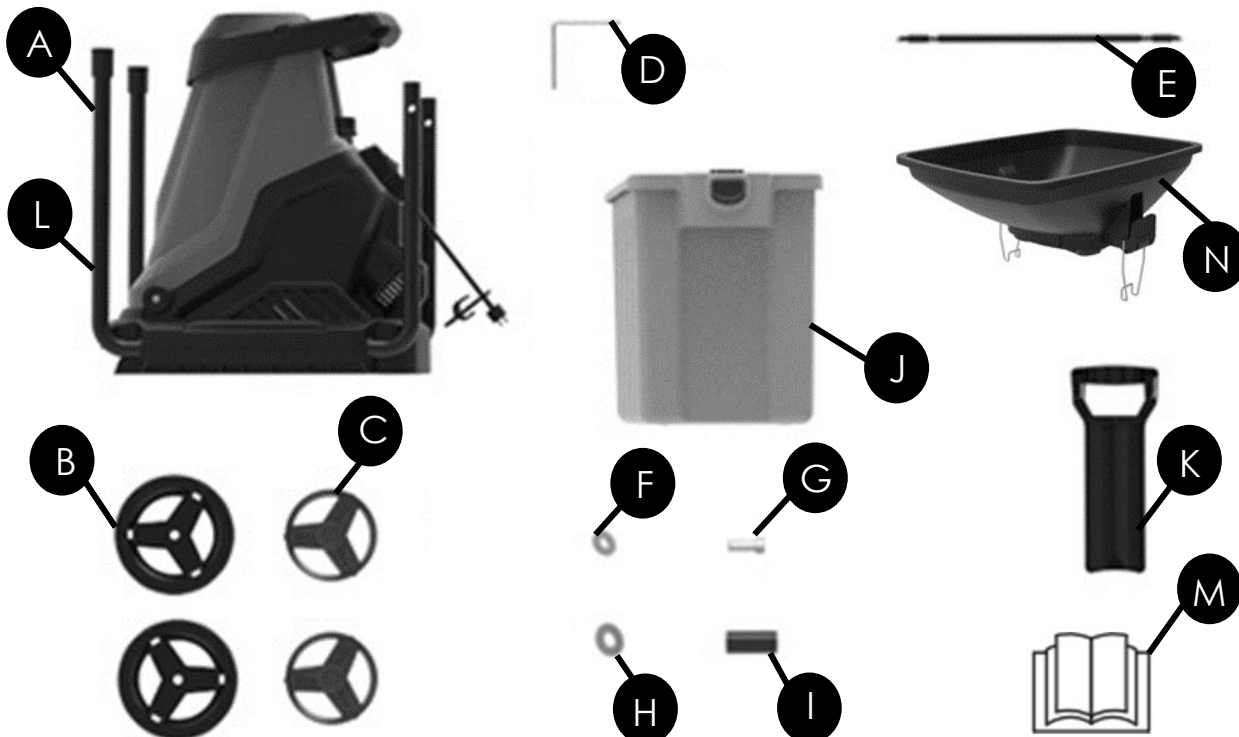

- A 3000W Garden Shredder (Main Unit)**  
Designed for shredding fibrous or woody garden waste.
- B 2 x Wheels**
- C 2 x Wheel Covers**
- D Hex Key**  
Use this to fasten the wheels to the axle.
- E Axle**  
This connects both legs and the wheels together.
- F 2 x Washer  $\phi 6.5$**
- G 2 x Head Hex Screws (with Spring washers)**
- H 4 x Washer  $\phi 10$**
- I 2 x Bushings**  
These slide on each side of the axle as part of the wheel assembly.
- J 50L Collection Box**
- K Paddle**  
Use this to press garden waste through the inlet chute.
- L Legs**  
These are part of the main unit and connect to the wheels and axle.
- M User Manual**  
Read this carefully before using the garden shredder.
- N Hopper**  
This connects to the inlet chute at the top of the machine.

# Features

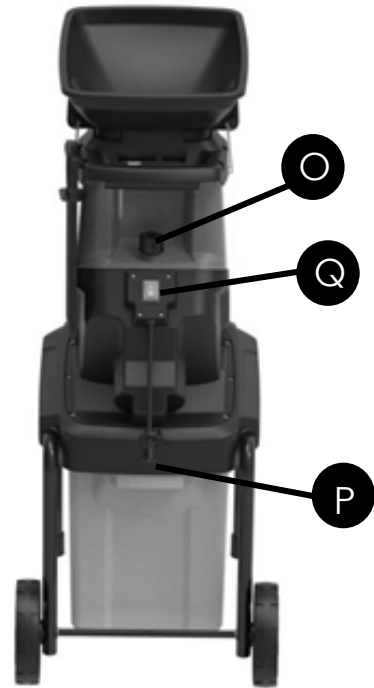
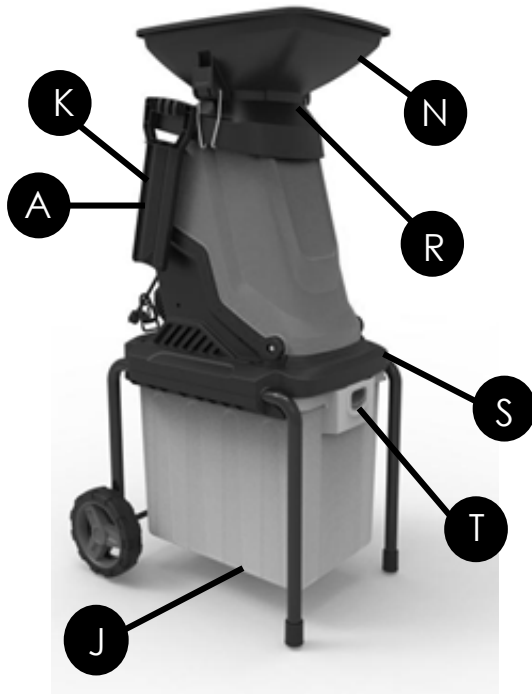

- A 3000W Garden Shredder (Main Unit)**  
Designed for shredding fibrous or woody garden waste.
- J 50L Collection Box**  
This is where the fibrous/woody garden waste gets collected once processed.
- K Paddle**  
Use this to press garden waste through the inlet chute.
- N Hopper**  
This connects to the inlet chute at the top of the machine.
- O Housing Lock**  
This locks/unlocks the main unit's cover.
- P Cable Strain Relief**  
This helps keep the cable suitably aligned and tidy during operation.
- Q ON/OFF Switch**  
Use this to switch the shredder on and off.
- R Feeding Chute**  
This is where you insert fibrous or woody garden waste to be processed.
- S Ejection Chute**  
This is where the processed garden waste is discharged out of the shredder.
- T Collection Box Latch**  
This allows you to remove and insert the collection box.

# Assembly

## Assembly Overview

There are 3 steps to the assembly:

**STEP 1.** Attaching The Wheels To The Support Legs

**STEP 2.** Attaching The Collection Box To The Main Unit

**STEP 3.** Attaching The Hopper To The Main Unit

### STEP 1: Attaching The Wheels To The Support Legs

**NOTE:** This section requires the Axle **(A)**, 2 x  $\phi 6.5$  washers **(B)**, 4 x  $\phi 10$  washers **(C)**, 2 x Head Hex Screws **(D)**, 2 x wheels **(E)**, 2 x wheel covers **(F)**, 2 x bushings **(H)** and the **hex key**. These are supplied in the box contents with the machine.

**NOTE:** This section also requires the use of a Phillips screwdriver to lock the axle into place when attaching the wheels. The Phillips screwdriver is also supplied with the product.

**NOTE:** When unboxing this product and its components, the **2 x head hex screws** and **4 x washers** and **2 x bushings** will be attached to the axle. Use the hex key to remove them from the axle before assembling the wheels.

1. Turn the main unit upside down and rotate the two support legs in the orientation as displayed in the diagram below.

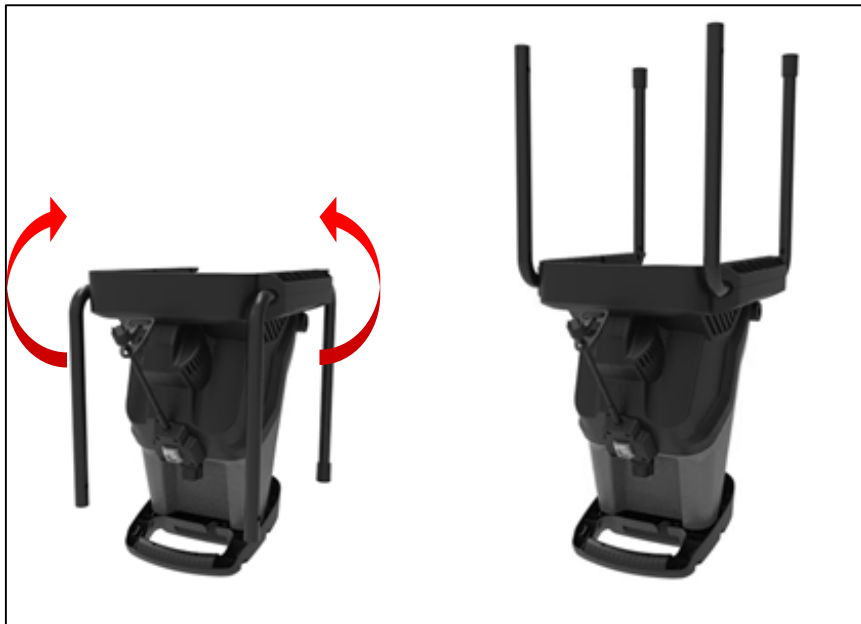

# Assembly

## STEP 1: Attaching The Wheels To The Support Legs (Continued)

2. Place the 2 x  $\phi 10$  washers (C) over the left and right ends of the axle (A).
3. Slide both ends of the axle through the holes located in the support legs.
4. Once the axle (A) is connected to both support legs, slide the remaining 2 x  $\phi 10$  washers (C) and 2 x bushings (H) over the parts of the axle that have been pushed through the support legs.
5. Slide the wheels (E) across the bushings (H) on both ends of the axle (A).
6. Take the 2 x head hex screws (D) and place the 2 x 6.5 $\phi$  washers (B) over both of the screws.
7. Screw and tighten both of the head hex screws (D) with 6.5 $\phi$  washers (B) into the wheels with the hex key until firmly secured.
8. Place the wheel covers over the wheels. Ensure the clips fitted on each wheel cover line up to the slots located in the rim of each wheel.

**NOTE:** We recommend using a Phillips screwdriver to lock the axle in place while tightening the head hex screws with the hex key. Ensure the wheel can rotate freely after tightening the head hex screws.

**NOTE:** Use the diagram below in conjunction with the above steps to secure the wheel and axle assembly to the support legs. Follow the sequence to its exact entirety.

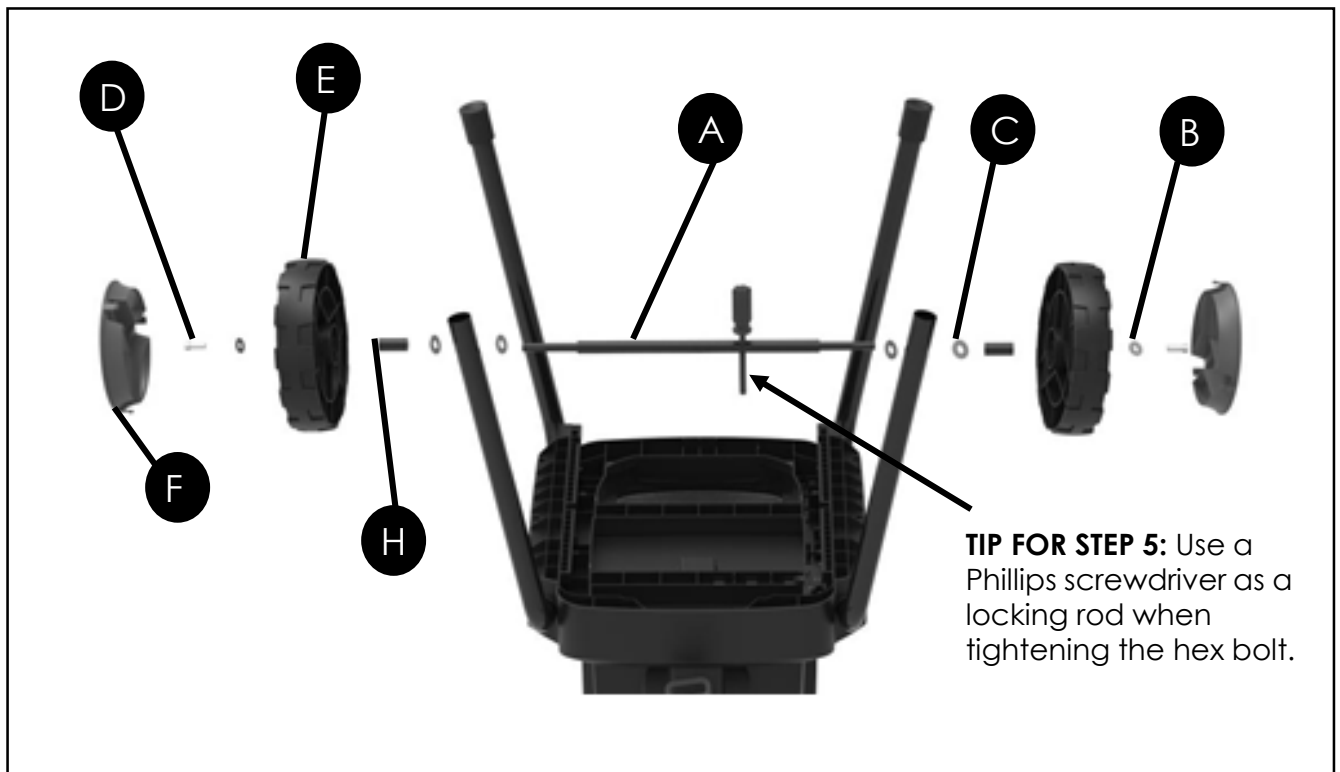

# Assembly

## STEP 2: Attaching The Collection Box To The Main Unit

1. Install the collection box to the main unit by sliding it into the grooves located next to the un-wheeled support legs at the front of the machine.
2. Push the collection box far enough back for the latch to lock. You will hear an audible click once the latch has been locked.

**NOTE:** To remove the collection box, press the latch and pull it away from the main unit.



# Assembly

## STEP 3: Attaching The Hopper To The Main Unit

**⚠ WARNING! NEVER install or attach the hopper when the shredder is connected to the power supply.**

1. Place the hopper over the top of the inlet chute. Ensure the mouth of the hopper perfectly aligns with the contour of the inlet chute.
2. Open the buckles to ensure the clips are fully extended in readiness to be attached on both sides of the machine.
3. Once the clips have been connected to the top of the main unit, close the buckles to secure the hopper to the machine.



# Operation

## Before Starting (Perform Checks)

1. Ensure the machine is in good working order. If damaged, do not use and seek assistance of qualified personnel to perform the necessary maintenance.
2. Check the condition of the cable before switching on the power.
3. Ensure that no objects or debris are trapped in the inlet chute prior to starting. Remove any debris if necessary.
4. Be mindful of your working area. Ensure the discharge area is suitably away from any person(s) general direction.
5. Remove any debris/obstacles from the work area which could impede operation.

## Starting Procedure

**⚠ YOU MUST read and understand the full safety instruction manual before starting the machine.**

1. Connect the plug to a power socket.
2. Press the switch to 'I' to start the shredder's motor.
3. Once the motor has been running for a few seconds, you can start shredding.

## Stopping Procedure

**⚠ WARNING! NEVER slacken off the housing lock before switching the machine off and disconnecting the plug from the power source.**

**⚠ WARNING! The shredding blades will continue to be active for a few seconds after the motor has been switched off.**

1. Press the switch marked 'O' to stop the shredder's motor.
2. Disconnect the plug from the power supply.



## Restart Procedure

**⚠ WARNING!** In the event of needing to remove a blockage from the blades within the main unit or from the inlet chute, a full restart will be required.

**⚠ WARNING! NEVER** attempt to remove a blockage or perform maintenance with the motor still running and connected to the power source.

1. Press the switch marked 'O' to stop the shredder's motor.
2. Disconnect the plug from the power supply.
3. Turn the housing lock anti-clockwise to open the main unit.
4. Remove the debris/blockage from affected area.
5. Close main unit. Turn the housing lock clockwise to lock the main unit back in place.
6. To restart the shredder, reconnect the plug to the power supply.

**⚠ IMPORTANT:** This shredder is fitted with a built-in safety switch. If the main unit's cover has not been adequately secured by tightening the housing lock, the shredder will not start. Ensure the housing lock has been tightened before starting the machine.

7. Press the switch to the 'I' position to restart the motor.



Ensure the housing lock has been fully tightened (clockwise) before starting the machine.



## Using The Paddle

**!** Your fingers must NEVER enter the inlet chute.

**!** NEVER use the paddle stick if the main unit is not fitted.

**!** DO NOT over reach.

**NOTE:** There is a paddle stick provided to help feed less bulky material such as small twigs, leaves, other garden waste and vegetation into the inlet chute.

1. Load the material into the inlet chute.
2. Insert the flat push stick into the inlet chute to push the material towards the blade disc.
3. Wait until all the material has been shredded before adding more material.



# Maintenance & Care

## General Maintenance

**⚠ WARNING! Turn OFF the machine, allow all moving parts to come to a complete stop and disconnect from the power source before maintaining the machine.**

**⚠ WARNING! You must ALWAYS wear protective clothing and protective gloves whenever performing maintenance on the machine.**

- Keep all nuts, bolts and screws tight to be sure the machine is in a safe working condition.
- Replace worn or damaged parts for safety. Only use manufacturer-recommended parts and accessories.

## Cleaning

**⚠ WARNING! Always disconnect the machine from the power source before any cleaning is undertaken.**

- Remove any excess debris after each use to prevent it from drying. Use a clean cloth to remove dirt, grease, etc.
- DO NOT use any water on any part of the main machine.
- Avoid using solvents when cleaning plastic parts. Most plastics are susceptible to damage from various types of commercial solvents and may be damaged by their use.
- Always ensure that ventilation openings are kept clear of debris.

# Maintenance & Care

## Blade Replacement

**!** ALWAYS wear gloves when working on the shredder's blades.

**!** WARNING! Ensure the machine is switched off and the plug has been disconnected from the power supply. Moving blades can cause serious injury.

**!** WARNING! Only replace worn or damaged parts with original replacements. Parts used from other manufacturers may damage the machine and can lead to the risk of serious injury.

**!** The blades have two cutting edges, which can be turned around. ALWAYS replace and turn the blades in pairs. DO NOT attempt to sharpen the blades.

1. Unscrew the housing lock anti-clockwise to open the main unit's cover.
2. Lock the blade plate in place by slotting a screwdriver through the access hole (as illustrated in the picture below).

**NOTE:** You will need to rotate the blade plate until the screwdriver slots between one of the blade openings.

Once perfectly aligned and locked in place, you will be able to reach the blade beneath the blade plate's protective metal casing.

3. Use the hex key to loosen and remove both screws on the blade to remove the blade.
4. When mounting the new blade, re-insert the screws and tighten with the hex key.
5. Repeat the above sequence in its exact entirety with the other blade.

Use the hex key to loosen and tighten blade screws.

Slot a screwdriver through the access hole and between a blade opening to lock the blade plate in place.

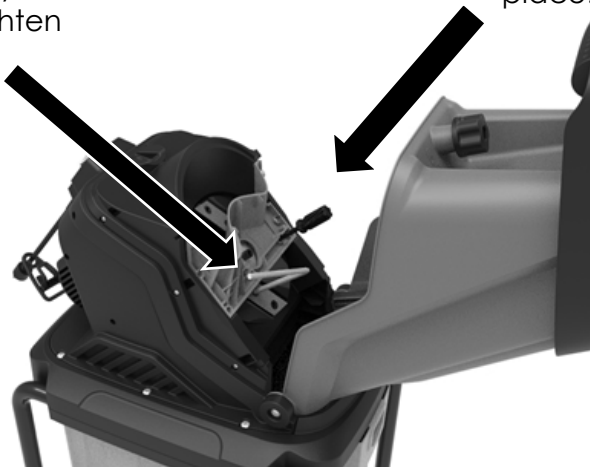

# Maintenance & Care

## Storage

**⚠ Keep the machine stored in a dry, level area away from damp, moisture and rain fall. Allow the machine to cool down before storing.**

- Make sure the machine is clean and dry before storing. You can keep the cable tidy by wrapping it around the hook on the rear of the machine. You can also store the gun and accessories in the slots at the rear of the machine.
- Ensure the machine is stored in a position, where any persons cannot step on, to attempt to reach items up high, due to risk of movement.
- DO NOT store the machine near an ignition source, such as a wood stove, gas or electric heater, or an appliance or heater with a pilot light.
- Store the machine out of reach of children or anyone who is not familiar with operation.
- DO NOT stack other items on top of the machine when in storage.
- Make sure the machine is stored away from direct sunlight. Store indoors or in a safe, frost-free area during severe weather and winter months.

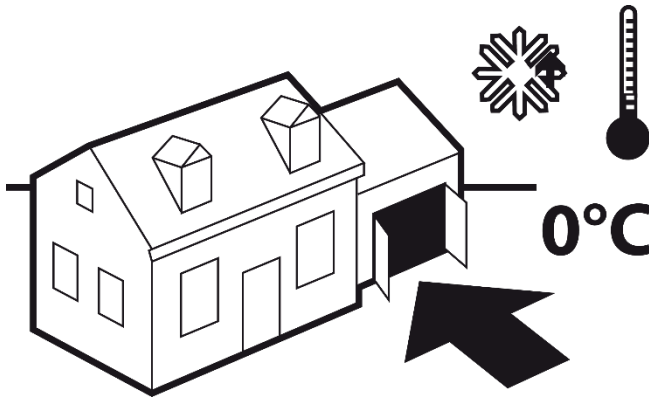

# POWER SPARES



No Hassle Returns



Same Day Dispatch\*



Over 10,000 Spare Parts



**QR Code** – Scan the QR code for a direct link to our website

**Our Website** : [power-spares.co.uk](http://power-spares.co.uk)

**Call us** : 01646 404406

**Email us** : [sales@power-spares.co.uk](mailto:sales@power-spares.co.uk)

To maintain your machine in peak operating condition, proper maintenance and care are crucial. Some machines have consumable parts that will need replacement to ensure they continue operating at their full potential. Power-Spares provide manufacturer parts for all your machines, ensuring they remain in peak condition.

## About Power Spares

Power-Spares has your back if you damage your lawn mower blade, find your spark plugs not sparking, or snap your recoil. Power-Spares operates under the trading name of Genpower Limited.

As part of the Genpower family, Power-Spares offers you the expertise, efficiency, and quality assurance of a large organisation. We leverage the latest warehousing, distribution, customer service, and inventory management technology to ensure you receive your parts as quickly as possible.

With extensive stock-holding of spare parts in our UK warehouses, Power-Spares is ready to assist you promptly when your machine needs repair. We're Committed to help you get back up and running as quickly as possible.

# Maintenance & Care

## Troubleshooting

Problem	Possible Cause	Solution
Motor not running	Power failure/unit is not plugged into a working socket.	Check to make sure the unit is plugged into a working outlet. Check the extension cable is not damaged.
	The overload protection has been activated.	Remove possible debris. Follow the <b>Restart Procedure (Page 22)</b> .
	The main unit's cover is open.	Check to ensure the cover is secure. Turn the housing clockwise to tighten.
	The collection box is not pushed into the right position.	Check to ensure the collection box is pushed right to the back and the collection box latch has been locked properly.
Garden waste not being pulled in	The material has jammed in the inlet chute.	Switch off the machine and disconnect from power supply. Open the main unit cover and remove the debris from affected area.
	Cutting blades are blocked	Switch off the machine, disconnect from power supply and open main unit cover. Remove the blade cover, clear debris and remount the blade cover.
	Shredding material in ejection chute	Switch off the machine and disconnect from power supply. Remove debris from the ejection chute.
Machine is not shredding to its optimum	Blades are worn	Refer to <b>Blade Replacement</b> procedure on Page 25.

# Technical Data

## Specification

<b>Model</b>	<b>HYSH3000E</b>
Power	3000W (P40)
Frequency	50Hz
Maximum Branch Thickness	45mm
Collection Bag Volume	50L
Sound Pressure Level (LpA)	95.2dB(A)
Sound Power Level (LwA)	101.83dB(A)
Guaranteed Sound Power Level	106dB(A)
Protection Type	IPX4
Net Weight	12.98kg

# Recycling & Disposal

## Recycling & Disposal

We do not offer a takeback scheme for the recovery of Waste Electrical Electronic Equipment (WEEE) & Batteries. Instead the responsibility to dispose of WEEE and/or Batteries is passed onto you by us.

So when it becomes necessary to dispose of your machine you must take it to your local Civic Amenity Site. For further information please contact your local Authority for disposal advice.

You MUST make sure that all unused oil and fuel is disposed of correctly either beforehand or at your local Civic Amenity Site.

- Under NO circumstances must any fuel or oil be put down any drains.
- Certain products contain WEEE waste which should not be disposed of in your domestic waste.
- You MUST recycle WEEE in accordance with your local authority or recycling centre.
- Certain products contain batteries which should not be disposed of in your domestic waste.
- You MUST recycle batteries in accordance with your local authority or recycling centre.
- Unwanted packaging and materials should be stored and taken to a recycling centre so it can be disposed of in a manner which is compatible with the environment.

We are a Member of the VALPAK National Compliance Scheme and our registration number is RM08660. For further information about disposal please contact your Local Authority.

You can also get more advice and guidance about recycling at the following website <http://www.recycle-more.co.uk>

Should you pass this product on to another user either sold or loaned, you MUST pass on this user manual. This will make sure that all other users can use and maintain this machine safely.

## Environmental Protection

1. Environmental protection should be a priority of considerable importance when using the machine, for the benefit of both social coexistence and the environment in which we live. Try not to cause any disturbance to the surrounding area.
2. You must comply with local regulations and provisions for the disposal of packaging, oils, fuel, filters, damaged parts or any elements which have a strong impact on the environment. This waste must not be disposed of as normal waste. It needs to be separated and taken to specified waste disposal centres where the material will be recycled.
3. You must comply with local regulations for the disposal of waste materials after mowing.
4. When disposing, do not pollute the environment with the machine, but hand it over to a disposal centre, in accordance with the local laws in force.

# EU Declaration Of Conformity

## Importer and Authorised Representative

Genpower Ltd  
Isaac Way, Pembroke Dock, SA72 4RW  
**Country of Origin:** China  
**Description:** 3000W Garden Shredder  
**SKU Code:** HYSH3000E  
**Date of Issue:** 31/05/2024

## Regulations and Directives of Compliance

- EC Council Directive (EU) 2014/30 Electromagnetic Compatibility
- EC Council Directive 2006/42/EC Machinery

## REFERENCES TO THE RELEVANT HARMONISED SAFETY STANDARDS USED OR REFERENCES TO THE OTHER TECHNICAL SPECIFICATIONS IN RELATION TO WHICH CONFORMITY IS DECLARED:

EN IEC 55014-1:2021  
EN IEC 55014-2:2021  
EN IEC 61000-3-2:2019+A1  
EN 61000-3-3:2013+A1+A2  
EN 60335-1:2012+A11+A13+A1+A14+A2+A15  
EN 50434:2014  
EN 62233:2008  
AfPS GS 2019:01 PAK

## Statement of Declaration

We the importer and authorised representative of the product described confirm conformity within the provisions of applicable regulations and directives listed within this document.

## Signed on Behalf of Genpower Ltd

**Place of Issue:** Genpower Ltd

**Signatory Name:** Roland Llewellyn

**Position:** Managing Director

*RJLlewellyn*  
.....



# Notes

# Notes

# Useful Information

## Check Out Our YouTube Channel

Our videos on YouTube include:

- Unboxing
- Assembly of your machine
- How to service your machine
- Products in use
- 'How To' videos
- Product features

Go to YouTube and search '**Hyundai Power Products**'.

## Warranty

Proof of purchase will be required before you make a warranty claim. Full warranty terms and conditions can be found on the HYUNDAI POWER PRODUCTS website:

[www.hyundaipowerproducts.co.uk](http://www.hyundaipowerproducts.co.uk)

## Manual Updates

Our manuals are constantly being reviewed and updated. Should you find an error, omission or something unclear, please contact us for assistance. We reserve the right to make any modifications without prior notice whenever necessary.

Our latest manuals are also placed online. All our manuals can be downloaded at:

[www.hyundaipowerproducts.co.uk](http://www.hyundaipowerproducts.co.uk)

## Returning Your Product

If you are returning your product, please contact the dealer for their returns policy.

## Leaving A Review

We work very hard to give all of our customers the best possible service. If you have any problems, before leaving negative feedback, please contact us to give us a chance to resolve the issue. We would be delighted if you left us positive feedback! To leave a review, please go to:

[uk.trustpilot.com/review/hyundaipowerequipment.co.uk](http://uk.trustpilot.com/review/hyundaipowerequipment.co.uk)

## Ordering Spare Parts

You can find the spare part you are looking for at [power-spare.co.uk](http://power-spare.co.uk)

# Product Record

## Information

As soon as you have purchased the machine, we recommend that you fill out the following. If you need to contact an authorised dealer or customer service for information on servicing, you may need to provide the following information.

Date Of Purchase:.....

Dealer Name:.....

Dealer Phone:.....

Model Number:.....

Serial/Batch Number:.....

# Contact Us

## Need Help? Talk To Our Experts

Our friendly aftersales team will be more than happy to help you.



### Phone

Call our team on 01646 687 880



### Email

[aftersales@hyundaipowerproducts.co.uk](mailto:aftersales@hyundaipowerproducts.co.uk)



### Online Live Chat

Go to [www.hyundaipowerproducts.co.uk](http://www.hyundaipowerproducts.co.uk)



### Post

Genpower Ltd, Isaac Way, Pembroke Dock, Pembrokeshire, SA72 4RW.



### Hyundai Support Website

Go to [hyundaisupport.co.uk](http://hyundaisupport.co.uk)

# HYUNDAI

POWER PRODUCTS



GENUINE PRODUCT OF  
HYUNDAI CORPORATION

For Inquiries, Please Contact:  
GENPOWER LTD  
Isaac Way, London Road,  
Pembroke Dock, UK, SA72 4RW.  
T: +44 (0) 1646 687 880  
E: [info@hyundaipowerproducts.co.uk](mailto:info@hyundaipowerproducts.co.uk)  
[www.hyundaipowerproducts.co.uk](http://www.hyundaipowerproducts.co.uk)